



Draft Report on
Retrospective Amendments
Relating to Indirect Transfer

Expert Committee
(2012)

**Draft Report of the Expert Committee on Retrospective Amendments
Relating to Indirect Transfer**

INDEX

S.No.	Topic	Page No.
	Executive Summary	4
1.	Constitution of the Expert Committee with terms of reference	12
2.	Indirect Transfer- an overview	14
2.1	Introduction	14
2.2	International Practices	17
2.3	Conventions in Tax Treaties	18
2.3.1	UN Model Convention	18
2.3.2	OECD Model Convention	18
2.3.3	Indian Double Tax Avoidance Agreements(DTAAs)	19
3.	Retrospective amendments relating to indirect transfer	20
3.1	An overview	20
3.2	Definition of term "transfer"	21
3.3	Explanation of term "property"	22
3.4	Explanation of term "through"	23
3.5	Explanation of phrase "capital asset situated in India"	24
3.6	Provisions in the Direct Taxes Code(DTC) Bill 2010	25
4.	Concerns expressed by stakeholders	27
4.1	Extra-territorial Operation of Law & Constitutional Validity	27
4.2	Meaning of the phrase "share or interest in a company or entity"	34
4.3	Definition of "substantially"	35
4.4	Meaning of the phrase "directly or indirectly"	38
4.5	Meaning of the word "value" and point of time for valuation	40
4.6	Concern of small shareholders	41
4.7	Concern of listed foreign company	45
4.8	Tax neutrality in cases of business reorganization abroad	47
4.9	Concerns of Foreign Institutional Investors	48
4.10	Concerns of Private Equity Investors	50
4.11	Implication of amendment of definition of word "transfer"	52

4.12	Levy of interest and penalty	56
4.13	Proportionality of taxation	58
4.14	Cascading effect on dividend taxation in multi-tier structure abroad	59
4.15	Conflicts with the tax treaties (DTAAs) of India	60
4.16	Treating assessee in default for non-deduction of tax on payments to non-residents.	64
Annexe-1	Copy of Notification dated 17 July 2012 constituting Expert Committee and subsequent Notifications dated 30 July 2012 and 1 Sept 2102 modifying the Terms of Reference.	
Annexe -2	International practice on taxation of indirect transfers.	
Annexe-3	Article 13 of UN Model Convention (2011)	
Annexe-4	FII investments in India –Direct and Synthetic.	
Annexe-5	International Practice on retrospective amendments.	
Annexe- 6	A comparative chart of indirect transfer provisions in the DTC 2009, DTC Bill 2010 and Finance Act, 2012	

Executive Summary: Recommendations

Vide Finance Act, 2012, certain retrospective amendments were made in Income-tax Act, 1961 (hereinafter referred to as the Act), intended to clarify and restate the legislative intent of the source rule of taxation for non-residents in India. In particular, they addressed situations where transfers took place exclusively between such non-residents—hence indirectly—of underlying assets in India. The relevant section 9(1)(i) of the Act became effective retrospectively as of 01 April 1962.

The language and scope of the amendments led, however, to apprehensions about the certainty, predictability and stability of tax laws in India. The legislation with retrospective application in particular obviating an earlier Supreme Court decision on the matter of indirect transfer was not expected and thus perceived in negative light. The present Committee was mandated to analyze the amended provisions. Based on inputs received from various stakeholders and the Committee's own analysis, the Committee is of the view that, as a matter of policy, Government should best avoid introducing fundamental changes in tax provisions without consultations and thus not anticipated by the taxpayer.

The adverse reactions to the amendments intermingled the two matters—retrospectivity in tax law, and indirect transfer—under the same rubric. This Report has attempted to untangle the two aspects. It addresses the issue of retrospectivity and prospectivity. It then proceeds to make a series of recommendations, including some that would apply if retrospectivity is opted for by Government, and others that would apply in either case.

The Committee concluded that retrospective application of tax law should occur in exceptional or rarest of rare cases, and with particular objectives: first, to correct apparent mistakes/anomalies in the statute; second, to apply to matters that are genuinely clarificatory in nature, i.e. to remove technical

defects, particularly in procedure, which have vitiated the substantive law; or, third, to “protect” the tax base from highly abusive tax planning schemes that have the main purpose of avoiding tax, without economic substance, but not to “expand” the tax base. Moreover, retrospective application of a tax law should occur only after exhaustive and transparent consultations with stakeholders who would be affected.¹

Recommendations

(1) Reflecting that the provisions relating to taxation of indirect transfer as introduced by the Finance Act, 2012 are not clarificatory in nature and, instead, would tend to widen the tax base, the Committee recommends that these provisions, after introducing clear definitions as recommended in this Report, should be applied prospectively. This would better reflect the principles of equity and probity in the formulation and implementation of commonly recognized taxation principles.

The Committee has, however, taken due care to examine the ramifications of the possibility of Government proceeding with retrospective application, and makes the following two recommendations in case Government opts for retrospective taxation of indirect transfer -

(i) No person should be treated as an assessee in default under section 201 of the Act read with section 9(1)(i) of the Act as amended by the Finance Act, 2012, or as a representative assessee of a non-resident, in respect of a transaction of transfer of shares of a foreign company having underlying assets in India as this would amount to the imposition of a burden of

¹ Indeed, reflecting the challenges behind just and correct application of retrospective application, there is a constitutional or statutory protection against it in several countries. Countries such as Brazil, Greece, Mexico, Mozambique, Paraguay, Peru, Venezuela, Romania, Russia, Slovenia and Sweden have prohibited retrospective taxation.

impossibility of performance. This would imply that Government could apply the provisions only to the taxpayer who earned capital gains from indirect transfer.

(ii) In all cases where demand of tax is raised on account of the retrospective amendment relating to indirect transfer u/s 9(1)(i) of the Act, no interest under section 234A, 234B, 234C and 201(1A) of the Act should be charged in respect of that demand so that there is no undue hardship caused to the taxpayer. Moreover, in such cases, no penalty should be levied in respect of the income brought to tax on application of retrospective amendments under section 271(1)(c) (for concealment of income) and 271C (for failure to deduct tax at source) of the Act.

The following recommendations would apply whether indirect transfer provisions apply prospectively or retrospectively-

(2) Section 9(1)(i) of the Act is a general source rule for a non-resident. It provides, *inter alia*, that any income accruing or arising, directly or indirectly, through transfer of a capital asset situated in India shall be deemed to accrue and arise in India and consequently be taxable. The words used in the clause, namely, "through", "transfer", "capital asset" and "situated in India" have been assigned additional meaning through insertion of Explanations vide Finance Act, 2012. As discussed in the Report, these Explanations need further clarifications as under -

(i) The phrase, "the share or interest in a company or entity registered or incorporated outside India," in Explanation 5 to Section 9(1)(i) of the Act should mean and include only such share or interest which results in participation in ownership, capital, control or management. Therefore, all other types including mere economic interest should not be contemplated within the ambit of Explanation 5.

(ii) The word “substantially” used in Explanation 5 should be defined as a threshold of 50 per cent of the total value derived from assets of the company or entity, as proposed in DTC Bill 2010. In other words, a capital asset being any share or interest in a company or entity registered or incorporated outside India shall be deemed to be situated in India, if the share or interest derives, directly or indirectly, its value from the assets located in India being more than 50% of the global assets of such company or entity.

(iii) The phrase “directly or indirectly” in Explanation 5 may be clarified to represent a “look through” approach which implies that, for the determination of value of a share of a foreign company, all intermediaries between the foreign company and assets in India may be ignored.

(iv) For the purposes of Explanation 5 –

(a) the value should refer to fair market value as may be prescribed²;

(b) the value is to be ascertained based on net assets after taking into account liabilities as well;

(c) for determination of value, both tangible assets as well as intangible assets are to be considered; and

(d) the value is to be determined at the time of the last balance sheet date of the foreign company with appropriate adjustments made for significant disposal/acquisition, if any, between the last balance sheet date and the date of transfer.

² For this purpose, Discount Cash Flow (DCF) method in case of service sector and Net Asset Value (NAV) method for non-service sector may be used.

(v) The phrase "an asset or" juxtaposed on the phrase "capital assets" in Explanation 5 to section 9(1)(i) of the Act appears to be an insertion to buttress the concept of capital assets. Since the objective is taxation of the transfer of capital assets alone, the phrase "an asset or" may be omitted. Indeed, it may lead to unintended consequences such as taxation of dividends paid by a foreign company.

(vi) As the provisions of section 9(1)(i) read with Explanation 5 of the Act specifically deals with transfer of shares of a foreign company having underlying assets in India, the general provisions of section 2(47) relating to transfer should not be applied on a stand alone basis.

(vii) The taxation of capital gains on indirect transfer should be restricted only to capital gains attributable to assets located in India. Thus capital gains should be taxed on a basis of proportionality between fair market value of the Indian assets and global assets of the foreign company, as proposed in DTC Bill 2010.

(3) In order to avoid undue hardship to small shareholders, it is recommended that, where shares or interest in a foreign company or entity derive, directly or indirectly, its value substantially from assets located in India, then the transfer of shares or interest in such company or entity outside India would not be subject to tax in India under section 9(1)(i) of the Act, if,

(a) in case such company or entity is the immediate holding company of the assets situated in India, the voting power or share capital of the transferor along with its associated enterprises in such

company or entity is less than 26%³ of total voting power or share capital of the company or entity during the preceding 12 months; or

(b) in other cases, the voting power or share capital of the transferor in such company or entity along with its associated enterprises during the preceding 12 months does not exceed such percentage which results in 26% of total voting power or share capital of the immediate holding company of the assets situated in India.

(4) Exemption may be provided to a foreign company which is listed on a recognized stock exchange and its shares are frequently traded therein. The terms "frequently traded" and "recognized stock exchange" may be defined as in the SEBI guidelines and RBI regulation on overseas investments by residents respectively.

(5) Transfer of shares or interest in a foreign company or entity under intra group restructuring may be exempted from taxation subject to the condition that such transfers are not taxable in the jurisdiction where such company is resident.

For this purpose, intra group restructuring may be defined as

(a) amalgamation or demerger as defined under the Act subject to continuity of at least three fourth ownership; or

(b) any other form of restructuring within the group (associated enterprises) subject to continuity of 100% ownership.

(6) The investments made by a Foreign Institutional Investor (FII) as per regulation of SEBI are subject to tax in India in the hands of the FII. Taxation of non-resident investors {including Participatory Note (PN) holders} investing, directly or indirectly, in the FII may lead to double or multiple taxation. It may, therefore, be clarified that where

³ The criterion is based on provisions of the Indian Companies Act (although not applicable to a foreign company) which stipulates that a shareholder having voting power of 26% or more can block a special resolution.

(i) a non-resident investor has made any investment, directly or indirectly, in an FII; or

(ii) the investment made by an FII in India represents, directly or indirectly, the underlying assets of investment by a non-resident,

then such non-resident will not be taxable in India on account of the provisions of section 9(1)(i) of the Act in relation to investments made by the FII in India.

(7) Private equity investors have expressed their concerns about likely taxation of gains arising to such investors outside India on account of redemption of their investments in the pooling vehicle or interse transfer amongst such investors. The recommendations suggested above in respect of "interest", small shareholding, business reorganizations, listed companies etc. should, in totality, address such concerns of private equity investors. To reiterate, private equity investors would be outside the coverage of taxation of indirect transfer where –

(i) the investment by the non-resident investor in a PE fund is in the form of units which do not result in participation in control and management of the fund;

(ii) the investor along with its associates does not have more than 26% share in total capital or voting power of the company;

(iii) the investee company or entity does not have more than 50% assets in India as compared to its global assets;

(iv) the investee company is a listed company on a recognised overseas exchange and its shares are frequently traded,

(v) the transfer of share or interest in a foreign company or entity results due to reorganization within a group.

(8) As shares of a foreign company having underlying assets in India are deemed to be situated in India under Explanation 5 to section 9(1)(i) of the Act, this has led to an unintended consequence of taxation of income in the form of dividend arising from such shares. It may, therefore, be clarified that dividend paid by a foreign company shall not be deemed to accrue or arise in India under section 9(1)(i) read with Explanation 5.

(9) In order to provide certainty to foreign investors, it may be clarified that, where capital gains arising to a non-resident on account of transfer of shares or interest in a foreign company or entity are taxable under section 9(1)(i) of the Act and there is a DTAA with country of residence of the non-resident, then such capital gains shall not be taxable in India unless-

- (i) the DTAA provides a right of taxation of capital gains to India based on its domestic law; or
- (ii) the DTAA specifically provides right of taxation to India on transfer of shares or interest of a foreign company or entity.

The aforesaid recommendations may be carried out through amendment of the Income-tax Act, 1961 or Income-tax Rules, 1962 or by way of an explanatory circular, as appropriate in law. The explanatory circular may also include various observations and interpretations⁴ made by the Committee while analyzing the retrospective amendments.

The Committee believes that such measures should allay the apprehensions of taxpayers and yet protect the tax base from erosion on account of indirect transfer of underlying assets in India.

⁴ Paragraphs 3.2, 3.3, 3.4, 3.5, 4.10, 4.11, 4.15 of the Report.

1. Constitution of the Expert Committee with terms of reference

The Prime Minister constituted an Expert Committee on General Anti Avoidance Rules (GAAR) to undertake stakeholder consultations and finalize the guidelines for GAAR after far more widespread consultations so that there is a greater clarity on many fronts. Copy of Notification dated July 17, 2012, is enclosed in Annexe-1. The Expert Committee on GAAR consists of:

- 1) Dr. Parthasarathi Shome - Chairman
- 2) Shri N. Rangachary, former Chairman, IRDA - Member
- 3) Dr. Ajay Shah, Professor, NIPFP - Member
- 4) Shri Sunil Gupta, Joint Secretary, Tax Policy & Legislation, Department of Revenue - Member

The Terms of Reference of the Committee are:

- i) Receive comments from Stakeholders and the general public on the draft GAAR guidelines which have been published by the Government on its website.
- ii) Vet and rework the guidelines based on this feedback and publish the second draft of the GAAR guidelines for comments and consultations.
- iii) Undertake widespread consultations on the second draft GAAR guidelines
- iv) Finalize the GAAR guidelines and a roadmap for implementation and submit these to the government.

Subsequently, the Prime Minister, through a Notification dated July 30, 2012, referred an additional issue {item (v) of the terms of reference} of the implications of amendment made to the Income Tax Act, 1961 (the Act) relating to the taxation of non-resident transfer of assets where the underlying asset is in India, particularly in the context of the tax liability of portfolio investors and Foreign Institutional Investors (FIIs). Copy of Notification enclosed in Annexe-1. By further Notification, dated September 1, 2012 (enclosed in Annexe-1), the Govt. modified item (v) to the Terms of Reference of the Committee to examine the applicability of the amendment on taxation of non-resident transfer of assets where the underlying asset is in India, in the context of all non-resident taxpayers.

As per plan, the Committee submitted its first report to the Government on 31st Aug, 2012, focusing on GAAR issues. It subsequently worked on the present Report that focuses on “indirect transfers” in reflection of the additional terms of reference given to the Committee on September 1, 2012. This Report reflects consultations and written representations from a number of Stakeholders including tax advisory firms comprising accountants and lawyers, chambers of commerce and industry, foreign investor associations, individual industry representatives, and policy makers. A list of consultations was provided in Annexe-3, and a list of received documents in Annexe-4 of the GAAR Report. Based on such inputs received in writing as well orally, the Committee submits its report on item (v) of its Terms of Reference as under.

2. Indirect Transfer – an overview

2.1 Introduction

With the liberalization of the Indian economy since the 1990s, substantial capital inflow has taken place into India. Apart from portfolio investment by foreign institutional investors, it includes long term investments in the form of foreign direct investment. Often, these investments are structured in a manner by which an investor creates a holding company in a favourable (no or low tax) jurisdiction with the holding company having a subsidiary or joint venture company in India. The business is carried out by the Indian company.

After a period of time when the investor wants to exit from India, the entire business in India is to be transferred⁵. He has two options i.e. either to sell his stake in the Indian company to another investor, or to sell his stake in the holding company to the new investor. In both situations, capital gains arise to the investor, though they occur through distinguishable or different channels. In the first case, the transaction involves transfer of assets located in India i.e. shares of the Indian company. In the second case, the transaction occurs outside India among foreign entities. It is this latter case that is referred to as indirect transfer, and comprises the focus of this second Report. The issue involved in this second Report is whether India has a right to tax capital gains arising out of such indirect transfers.

To elaborate, India has source based taxation, i.e. any income accruing or arising, or deemed to accrue or arise, in India to a non-resident is taxable in India. In case of sale of shares of an Indian company (the first case mentioned above), the situs of shares is in India and the transfer of shares also takes place in India. Hence, income accrues and arises in India.

To avoid uncertainty, through a deeming fiction, income through transfer of any capital asset situated in India is deemed to accrue or arise in India. A question arises if, despite the fact that the underlying asset is in India, when the transfer of shares of the holding company takes place, it occurs between two non-residents. Hence, where is the situs of shares of the foreign company: is it in the foreign jurisdiction where the company is registered or in the place where the underlying assets of the company are situated (i.e. where the main business activities are taking place). It was argued by Revenue that

⁵ Even in the case of a partial exit or entering into a joint venture, a part of the interest in the business is to be transferred.

by transfer of shares of the holding company, it is the business assets located in India that are transferred, albeit indirectly. Hence, the capital gains should be taxable in India. The Supreme Court held otherwise in its verdict dated 20 January 2012 pertaining to the Vodafone case.

As an example, let us consider a case of an investor Alpha, who is a resident company of the United States. Alpha incorporates a hundred percent owned company Subco in Cayman Islands. Subco makes an equity investment of \$100 million in an Indian company Indco in the year 2000. The structure of investment can be illustrated as under –

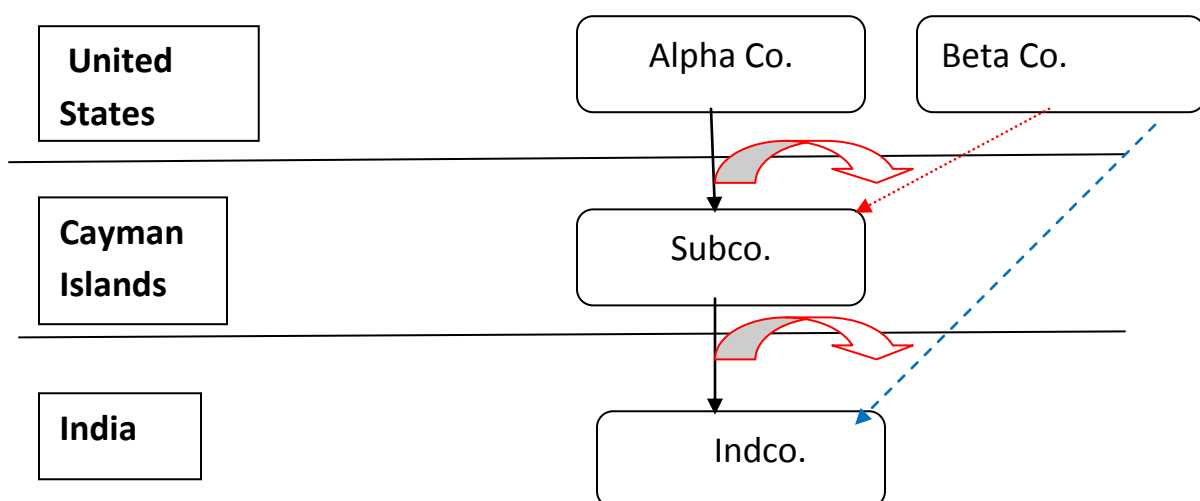

In the year 2010, Alpha Co. wants to exit. There is a buyer Beta Co., a company resident of the U.S., for US\$ 500 million. Alpha has two options. First, to sell its shares in Indco held by Subco to Beta Co. so that Beta becomes a *direct* owner of Indco. Or, second, to sell its shares of Subco to Beta Co. so that Beta becomes an *indirect* owner of Indco. The two options can be illustrated as under-

Option 1

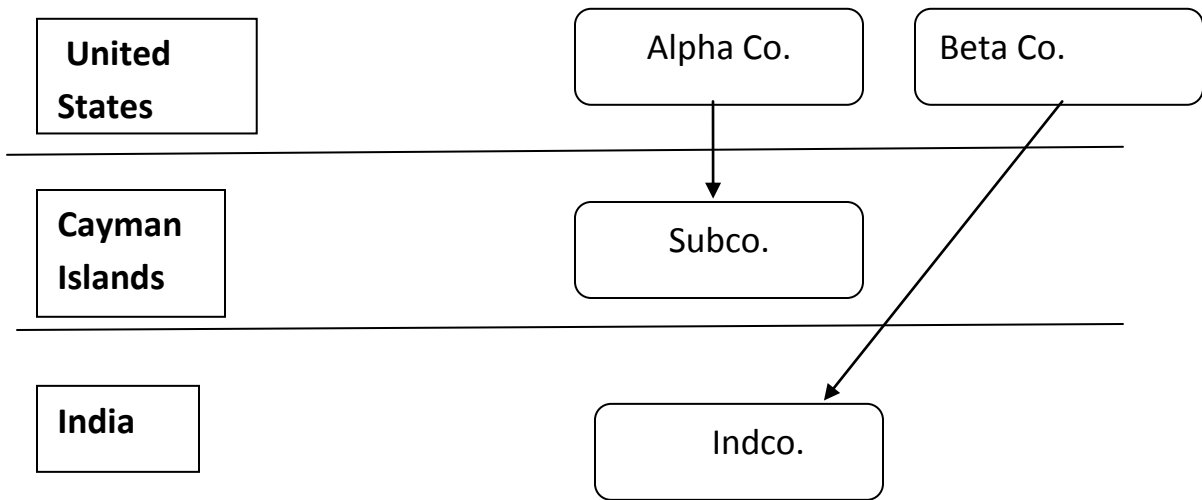

Option 2

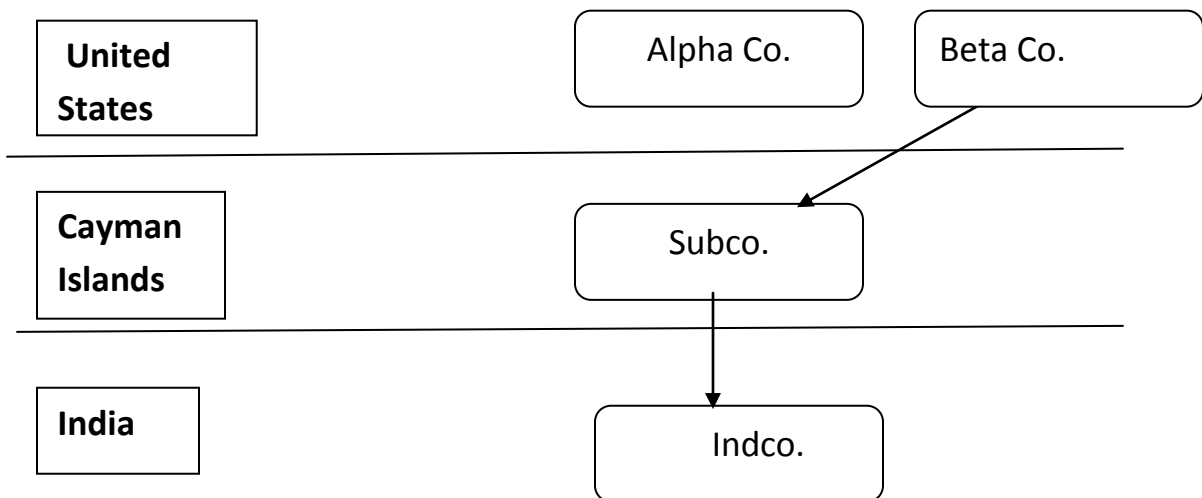

In the first option, Subco will be liable to tax in India on the capital gains of US\$ 400 million as there is a direct transfer of a capital asset (being shares of an Indian company) situated in India. In the second option, there would not be any tax liability as there is no direct transfer of capital asset situated in India as per law interpreted by the Supreme Court in the Vodafone case.

Government made a retrospective amendment to the Income-tax Act, 1961 (hereinafter referred to as the Act) through the Finance Act, 2012 that countered the Supreme Court judgment, with its scope and commensurate impact going back to 01 April 1962. This legislation by Parliament annulled the legal basis of the Supreme Court's judgment on Vodafone.

While the amendment was apparently intended to affect only those cases where India has not given up its right of taxation under a tax treaty or which resulted in double non-taxation, nevertheless, the language, interpretation and, consequently, the scope of the amendment raised concerns regarding the tax implications for foreign investors. In this context, it is worthwhile considering what positions other countries have taken on this matter. This is reviewed next.

2.2 International Practices⁶

An examination of the issues of taxation of indirect transfer in various jurisdictions reveals little uniformity of approach. Countries may be grouped in two categories following their taxation basis :

- Developed countries tend to follow residence based taxation so that a non-resident is not taxable on capital gains arising in the source country. The exception is real estate-this is the case of the US and Singapore. Russia and Australia also tax immovable property with the condition that the foreign entity (whose shares are being transferred) should have more than 50% of its assets consisting of real property in the source country. Canada is the same and adds timber and natural resources.
- Among emerging economies, China places under consideration taxation of indirect transfers if the transfer takes place through an SPV in a low tax jurisdiction with a tax rate below 12.5%. Israel taxes capital gains on transfer of shares of a foreign company having underlying assets in Israel but in a proportionate manner, and exempts securities traded in stock exchanges, venture capital and some others. It does not use a threshold. Brazil disregards intermediate company on the basis of bonafide or business purpose i.e. it adopts a look-through approach.

⁶ Based on submissions made by professional companies and information available in the public domain.

A more detailed account is provided in Annexe-2.

2.3 Conventions in Tax Treaties

Countries enter into bilateral agreements with each other in order to avoid double taxation of income and to prevent tax evasion. These agreements are commonly known as Double Tax Avoidance Agreements (DTAAs) or Double Tax Conventions (DTC) or Tax Treaties. These treaties provide rules for distribution of income for taxing purposes between source country and residence country of the taxpayer. The treaties do not impose any tax liability if there is no liability under the domestic law. These treaties are mainly based on the OECD Model Convention (MC) or UN Model Convention.

2.3.1 UN Model Convention

Article 13 of UN MC (2011) deals with income in the nature of capital gains, whose para 5 deals with indirect transfer. Para 5 is, therefore, of relevance here :

5. Gains, other than those to which paragraph 4 applies⁷, derived by a resident of a Contracting State from the alienation of shares of a company which is a resident of the other Contracting State, may be taxed in that other State, if the alienator, at any time during the 12 month period preceding such alienation held directly or indirectly at least ___ per cent (the percentage is to be established through bilateral negotiations) of the capital of that company.

Further details of the UNMC are provided in Annexe-3.

2.3.2 OECD Model Convention

The Article 13(4) of the OECD MC reads as under –

*"4. Gains derived by a resident of a Contracting State from the alienation of shares deriving more than **50 per cent** of their value **directly or indirectly** from **immovable property** situated in the other Contracting State may be taxed in that other State."* (emphasis added)

⁷ Para 4 applies to immovable property. Hence, para 5 applies to other than immovable property.

It is similar to UN MC of 2003 but is more specific in that 50 percent is specified. The Commentary on this article has suggested the following restrictions -

- (i) to restrict the application of the provision to cases where the alienator holds a certain level of participation in the entity;
- (ii) to consider that the paragraph should not apply to gains derived from the alienation of shares of companies that are listed on an approved stock exchange of one of the States;
- (iii) to gains derived from the alienation of shares in the course of a corporate reorganization; or
- (iv) where the immovable property from which the shares derive their value is immovable property in which a business is carried on (such as a mine or a hotel).

However, these are left to States to decide through bilateral negotiations.

2.3.3 Indian Double Tax Avoidance Agreements (DTAAs)

In most of the DTAAs India has entered into, the language of Article 13(4) of the OECD MC has been used but (1) instead of 50% threshold, the words "mainly" or "principally" has been used; (2) the restrictions as suggested in the commentary on OECD MC do not find place in the treaties.

3. Retrospective amendments relating to indirect transfer: Concepts and implications

3.1 An overview

Section 5 of the Act provides the scope of income taxation of a person in India. In case of a resident person (as defined in section 6), his global income is taxable in India. In case of non-resident person, only income which is received in India or income that accrues or arises, or is deemed to accrue or arise, in India is taxable.

Section 9 of the Act specifies cases of income, which are deemed to accrue or arise in India. This is a legal fiction created to tax income, which may or may not arise in India and would not have been taxable but for the deeming provision created by this section. Sub-section (1) (i) provides a set of circumstances in which income accruing or arising, directly or indirectly, is taxable in India. The clause mentions that the following incomes shall be deemed to accrue or arise in India :—

"9(1)(i) all income accruing or arising, whether directly or indirectly,
-through or from any business connection in India, or
*-through or from any **property** in India, or*
-through or from any asset or source of income in India, or
-through the transfer of a capital asset situated in India."

The section codifies source rule of taxation wherein the state where the actual economic nexus of income is situated has a right to tax the income irrespective of the place of residence of the entity deriving the income. One of the limbs of clause (i) is income accruing or arising directly or indirectly through the transfer of a capital asset situated in India. The legislative intent of this clause is to widen the source rule as it covers incomes which are accruing or arising directly or indirectly.

Finance Act 2012 has brought out certain clarificatory amendments with retrospective effect which would have its application in taxation of capital gains in an offshore transaction by inserting explanations to the terms "transfer", "property", "through" and "capital asset situated in India".

3.2 Definition of term “transfer”

Definition of the term “**transfer**” in clause (47) of section 2 has been explained as under-

‘Explanation 2.—For the removal of doubts, it is hereby clarified that “transfer” includes and shall be deemed to have always included disposing of or parting with an asset or any interest therein, or creating any interest in any asset in any manner whatsoever, directly or indirectly, absolutely or conditionally, voluntarily or involuntarily, by way of an agreement (whether entered into in India or outside India) or otherwise, notwithstanding that such transfer of rights has been characterized as being effected or dependent upon or flowing from the transfer of a share or shares of a company registered or incorporated outside India’.

Thus besides the general meaning of the term “transfer” as defined in clause (47), it includes in its ambit –

- (a) disposing or parting with an asset,
- (b) disposing or parting with an interest in an asset,
- (c) creating any interest in an asset,

The above activity may be carried out in any manner whatsoever including

- (A) directly or indirectly
- (B) absolutely or conditionally,
- (C) voluntarily or involuntarily, or
- (D) by way of an agreement (whether entered into in India or outside India) or otherwise

Further it is irrelevant whether such transfer of rights has been characterized as being effected or dependent upon or flowing from the transfer of a share or shares of a company registered or incorporated outside India.

Finally, note that by insertion of the phrase “shall be deemed to have always included”, the matter of retrospectivity is brought into the scope of transfer and, as its extension, indirect transfer.

Thus, the definition of “transfer” has been widened through the amendment to include activities which might not have been covered prima-facie by sub-clauses of clause (47). For example pledge of property, mortgage of property. It may also cover creating an interest of a third party in a partnership entity by parting with a part of interests of existing partners.

As per the amendment, transfer includes indirect disposal of the property as well. For instance, if shares of a holding company are transferred, then it may be said that shares of subsidiary company are transferred (indirectly).

However, it is not clear whether transfer of 100% shares of holding company or transfer of controlling interest in holding company, or a single share transfer of holding company, would amount to transfer of shares of subsidiary company or not.

As all transfers of capital assets are subject to tax under section 45 as capital gains, it may lead to practical difficulties in implementation as well as income computation mechanism as discussed below in para 4.11. These matters are kept in mind in making recommendations.

3.3 Explanation of term “property”

Clause (14) of section 2 defines the term “capital asset” as a property of any kind The term “property” used herein has been explained as under-

‘Explanation.—For the removal of doubts, it is hereby clarified that “property” includes and shall be deemed to have always included any rights in or in relation to an Indian company, including rights of management or control or any other rights whatsoever’.

As rights of management or control of a company flow from the shareholding of the company, the legislature has intended to create a bisecting approach whereby the right of management or control or any other rights in a company may be treated as a separate property than the shares being property. This is intended to cover situations where some assets such as right to control or management in a company are being transferred separately from the transfer of shares of the company.

It is not necessary that transfer of control and management of a company shall always be transferred along with transfer of shares. In certain

circumstances, the management and control can be transferred for a consideration without transferring any share. For instance, a company X Ltd has paid up capital of Rs 10,000 of 100 shares of Rs.10 each. A and B are two shareholders of the company with 50 shares (i.e. each shareholder having 50% control in the company). The company X Ltd comes out with a right share issue and issues 100 shares to shareholder A only. Thus, A has 150 shares (i.e. 75% of total capital) and B has only 50 shares (i.e. 25% of total share capital). For getting such majority control in the company, the shareholder A pays a substantial sum to shareholder B so that shareholder A may subscribe fully to the right share issue. Thus, control and management of the company are transferred to A without there being any sale of share by B to A⁸. The majority control can also be acquired by A if shareholder B divests its entire shareholding to the public under an Initial Public Offer (IPO).

Thus, the rights of management or control or any other right in a company need not always be considered as a separate property other than shares except in some circumstances where such property has been dealt with separately from shares.

3.4 Explanation of term "through"

The meaning of the expression "through" in clause (i) of sub-section (1) of section 9 has been explained as

'Explanation 4.—For the removal of doubts, it is hereby clarified that the expression "through" shall mean and include and shall be deemed to have always meant and included "by means of", "in consequence of" or "by reason of".'

In the first three limbs of section 9(1)(i), both words "through" and "from" have been used whereas the fourth limb uses only the word "through". This would imply that "through" is different from "from". The legislature has explained the word "through" to mean "by means of", "in consequence of" or "by reason of". Thus, "through" is wider in interpretation than "from".

⁸ In 2002-03, Suzuki Motor Company Ltd, Japan took over control in Maruti Udyog Ltd by hiking its stake in the company from 50% to 54.2% by subscribing to rights issue and paid a control premium of Rs 1,000 crore to Govt. of India for gaining a majority stake in the company.

In the context of indirect transfer, where an Indian company is to be transferred, and for that reason shares in the holding company are transferred, it would imply that income arising on transfer of shares of the holding company is by reason of transfer of the Indian company, and consequently it should be taxable in India.

3.5 Explanation of phrase “capital asset situated in India”

The meaning of the expression “**asset or capital asset situated in India**” in clause (i) of sub-section (1) of section 9 has been explained as under:

‘Explanation 5.—For the removal of doubts, it is hereby clarified that an asset or a capital asset being any **share or interest in a company or entity** registered or incorporated outside India shall be deemed to be and shall always be deemed to have been situated in India, if the share or interest derives, **directly or indirectly**, its value **substantially** from the assets located in India.’ (emphasis added)

Thus, shares of a foreign company (holding company), which holds substantial investment in India, shall be deemed to be situated in India and consequently, any transfer of such shares, even outside India, shall be taxable in India under the domestic law. However, the terms “share or interest in a company or entity”, “directly or indirectly”, “value” and “substantially” have not been defined and may, therefore, lead to ambiguity.

The apparent objective of insertion of Explanation 5 is to bring capital gains arising on transfer of a capital asset having underlying assets in India into the taxable income under the head capital gains. The explanation is not restricted to capital asset but extends to any other asset as well. The four limbs of section 9(1)(i) refer to *situs* of any capital asset and not all assets. Use of phrase “an asset” may widen the scope of sec 9(1)(i) and lead to ambiguity in interpretation. For instance, in the case of a trader in derivative securities outside India having underlying assets in India, the securities may be deemed to be situated in India and consequently the entire business income may be taxed in India without satisfaction of the business connection requirement. It may also lead to taxation of dividend income from foreign companies as discussed in section 4.14 of this Report.

In view of the above, it is recommended that the phrase “an asset or” in the Explanation 5 to section 9(1)(i) of the Act may be omitted through amendment.

3.6 Provisions in the Direct Taxes Code (DTC) Bill 2010

The provisions in the DTC Bill are the same as in the Act (before amendment by Finance Act, 2012) except the following additional relief⁹ provided therein-

(i) In case the total value of assets of the foreign company in India is less than 50% of the value of the global assets of the company, transfer of shares of the foreign company by its shareholders shall not be taxable in India; and

(ii) Where the transfer of shares of a foreign company is subject to tax in India, the gains shall be taxable only in that proportion of total gains which Indian assets bear to total global assets.

A comparative chart of indirect transfer provisions in the DTC 2009, DTC Bill 2010 and Finance Act, 2012 is enclosed as Annexe- 6.

Recommendations of the Parliamentary Standing Committee on provisions of the DTC Bill, 2010

The DTC Bill, 2010 seeks to tax income of a non-resident, arising from indirect transfer of a capital asset, situated in India. The Standing Committee has recommended that

- Exemption should be provided to
 - transfer of small share-holdings in the foreign company;
 - transfer of listed shares in major stock exchanges of the foreign company outside India; and
 - intra group restructuring outside India.

because applying the provisions on taxation of indirect transfer in such instances will cause undue hardship to the non-resident shareholder.

⁹ Clause 5(1)(d) read with Clause 5(4)(g) and Clause 5(6) of the DTC bill 2010

- The criteria for computing Fair Market Value (FMV) of assets at any time during 12 months preceding the transfer date is onerous, therefore it should be provided that comparison could be made on a particular date like the balance sheet date immediately preceding the date of transfer.

4. Concerns expressed by Stakeholders

In the representations by Stakeholders, the main doubt expressed by them has been that the provisions seeking to tax offshore transfers have been introduced to tax offshore mergers and acquisitions, where Indian assets are sought to be transferred indirectly; however, the provisions are widely worded to cover within their ambit, offshore transfers by investors in a fund, potentially leading to unintended, multiple taxation of the same gains. This has created uncertainty in the minds of investors about the interpretations that would be made by the Indian legal and tax system. This has, in turn, led to a shift in the perception about the safety of investing in India.

4.1 Extra-territorial operation of law & constitutional validity

4.1.1 Extra-territorial operation

Submission by the Stakeholders

Article 245 of the Constitution empowers the legislature to enact laws for the whole or any part of the territory of India. There should be sufficient nexus with the territory of India¹⁰. Income arising out of operations in more than one jurisdiction would have territorial nexus with each of the jurisdictions on actual basis, hence it may not be correct to tax the entire income in one jurisdiction¹¹.

It has also been argued that extraterritorial taxation violates sovereign rights of other nations. Principles of international comity demand that a reasonable exercise of fiscal jurisdiction be employed in a manner that gives due recognition to the sovereign rights of other nations.

Analysis

Article 245 of the Indian Constitution reads as follows:

“245. (1) Subject to the provisions of this Constitution, Parliament may make laws for the whole or any part of the territory of India,

¹⁰ Wallace Bros, Bombay HC [1948] FCR 1, GVK Industries, SC (2011) 332 ITR 30

¹¹ Ishikawajima Harima Heavy Industries (2007) 288 ITR 408

and the Legislature of a State may make laws for the whole or any part of the State.

(2) No law made by Parliament shall be deemed to be invalid on the ground that it would have extra-territorial operation."

In the case of Electronics Corporation of India Ltd. (ECIL), the Supreme Court referred the matter, being of substantial public importance, to a Constitution Bench after making the following observations –

- The operation of the law can extend to persons, things and acts outside the territory of India.
- Reliance was placed on the decision of the Privy Council in the case of British Columbia Electric Railway Co. Ltd. v. King [1946] AC 527, 542 (PC) wherein it was stated that -
"A Legislature which passes a law having extra-territorial operation may find that what it has enacted cannot be directly enforced, but the Act is not invalid on that account, and the courts of its country must enforce the law with the machinery available to them."
- The provocation for the law must be found within India itself. Such a law may have extra-territorial operation in order to sub serve the object and that object must be related to something in India. It is inconceivable that a law should be made by Parliament in India which has no relationship with anything in India.

However, the matter was not pursued by the applicant, being a public sector company and therefore it is still an open issue. The decision did clarify one issue that, on the grounds of non-enforceability in India, a law cannot be held as invalid. The reference was, however, made on the second issue i.e. whether there was sufficient nexus with India or not.

In the law as amended by the Finance Act 2012, there is nexus with India as the foreign company should have substantial assets in India. Whether substantial assets in India constitute sufficient nexus, depends on how 'substantial' is interpreted.

Real estate companies having principal assets in the source country and, in particular, more than 50% of global assets in the source country, have been internationally accepted as having sufficient nexus to be taxed on the transfer of their shares outside the source country. On the other hand, no such clear position has emerged in the case of non-real estate investment, which is the main area of contention being addressed here.

Comments

In view of the above, and as discussed below, while there is no restriction in the Constitution as per Article 245(2) making provisions pertaining to extra-territorial operations the interpretation and application of the term “substantially” relating to non-real estate investment needs to be done with caution to ensure that, there is adequate nexus with India. The recommendation for quantification of “substantially” is made later in this Report.

4.1.2 Constitutional validity of retrospective amendments

Submission by the Stakeholders

Retroactive amendments relating to indirect transfers violate Article 14 of the Constitution which guarantees the fundamental right against arbitrary and unreasonable treatment. The amendment is not merely clarificatory but significantly expands the scope of India’s source rules.

Directive by the Revenue to deduct tax on a transaction that took place before the date of amendment, leads to a situation of impossibility of performance.

Recently, the Gujarat High Court¹², while deciding a number of civil appeals referred to it by the Supreme Court, held that amendment to section 80HHC of the Act is violative for its retrospective operation in order to overcome the decision of the Tribunal and, at the same time, for depriving the benefit earlier granted to a class of assesseees whose assessments were still pending although such benefit would be available to assesseees whose assessments were already concluded. In other words, in this type of substantive amendment, retrospective operation can be given only if it is for the benefit of

¹² Guj HC, Advani Exports and Ors, 2012

the assessee but not in a case where it affects even a small section of the assessee adversely.

Analysis

Parliament is endowed with plenary powers of legislation, and it is competent to legislate with prospective or retrospective effect and such power to legislate retrospectively is upheld by the Courts¹³. However, this power is subject to a caveat that such retrospective legislation should not be unreasonable.

It is not the mandate of the Committee to examine the constitutional validity of the retrospective amendments but to look at it from a policy perspective. Retrospective amendments can be of following types-

- (i) to correct apparent mistakes/anomalies in the Statute
- (ii) to remove technical defects, particularly in procedure, which had vitiated the substantive law
- (iii) to "protect" the tax base from highly abusive tax planning schemes that have the main purpose of avoiding tax, without economic substance
- (iv) to "expand" the tax base.

Retrospective amendments as mentioned at (i) & (ii) are necessary and fair as they do not create any additional burden on the taxpayer. Retrospective amendments at (iii) above may also be justified as any avoidance of tax through exploitation of any loophole in the system means a windfall to a dishonest taxpayer at the cost of general body of the taxpayers¹⁴. However, retrospective amendment as mentioned at (iv) is against the basic tenet of the law as it affects the certainty of law.

The retrospective amendments carried through Finance Act, 2012 relating to indirect transfer have been specified by the Government as clarificatory in nature and as a restatement of the legislative intent. The amendments have been made effective from the date the original provisions were enacted i.e. 01 April 1962 and all these amendments are in the nature of explanations. Let us analyse various provisions of the Act to see if there is any indication of such legislative intent in the past.

¹³ Ujagar Prints v. Union of India, [1989] 3 SCC 488; National Agricultural Co-operative Marketing Federation of India Ltd. v. Union of India (2003) 260 ITR 548 SC; Rai Ramkrishna & Ors. v. State of Bihar (1964) 1 SCC 897.

¹⁴ R v HMRC [2011] EWCA Civ 89 in respect of retrospective amendment of section 58 of UK Finance Act, 2008

Section 2(47)- definition of "transfer"

The clause defines the term "transfer" in an inclusive manner only and does not provide an exhaustive definition. The sub-clause (vi) is reproduced as under-

"2(47)"transfer", in relation to a capital asset includes,-....."

- (vi) *any transaction (whether by way of becoming a member of, or acquiring shares in, a cooperative society, company or other association of persons or by way of any agreement or any arrangement or in any other manner whatsoever) which has the effect of transferring, or enabling the enjoyment of, any immovable property.*

It may be seen that this sub-clause specifically deals with the concept of indirect transfer but it is limited only to immovable property. If share of a company is transferred, which enables enjoyment of immovable property, it may be treated as transfer of immovable property. This provision was introduced with effect from 1.4.1988 vide Finance Act, 1987.

Thus, the concept of indirect transfer was restricted to immovable property.

Section 48 – Computation of capital gains

One of the heads of computation of income is capital gains. The gains on transfer of a capital asset is taxed under this head. The section 48 provides the mode of computation of capital gains as sales consideration minus cost of acquisition including cost of improvement.

First proviso to the section 48 reads as under –

Provided that in the case of an assessee, who is a non-resident, capital gains arising from the transfer of a capital asset being shares in, or debentures of, an Indian company shall be computed by converting the cost of acquisition, expenditure incurred wholly and exclusively in connection with such transfer and the full value of the consideration received or accruing as a result of the transfer of the capital asset into the same foreign currency as was initially utilized in the purchase of the shares or debentures, and the capital gains so computed in such foreign

currency shall be reconverted into Indian currency, so, however, that the aforesaid manner of computing of capital gains shall be applicable in respect of capital gains accruing or arising from every reinvestment thereafter in, and sale of, shares in, or debentures of, an Indian company :"

It provides that cost of acquisition, sale consideration of the capital asset being shares of an Indian company shall be considered only in the currency initially utilized for acquisition and gains have to be first computed in that currency, and thereafter to be converted in foreign currency. The provision intends to guard a non-resident from fluctuation in foreign currency.

The beneficial provision is applicable only in case of shares of Indian company. Where capital gains of a non-resident are taxable on transfer of shares of a foreign company having underlying assets in India, no such benefit is available to him. There is no rationale that such a benefit of protection from foreign exchange fluctuation should not be available when a non-resident makes an investment in a foreign company instead of an Indian company.

Thus, the computation mechanism does not deal with the taxation of indirect transfers.

Section 47 – transactions not regarded as transfer

Certain transactions specified in section 47 are excluded from the charging section for capital gains. Following sub-clauses cover overseas amalgamation and demerger between foreign companies –

“(via) any transfer, in a scheme of amalgamation, of a capital asset being a share or shares held in an Indian company, by the amalgamating foreign company to the amalgamated foreign company, if—

(a) at least twenty-five per cent of the shareholders of the amalgamating foreign company continue to remain shareholders of the amalgamated foreign company, and

(b) such transfer does not attract tax on capital gains in the country, in which the amalgamating company is incorporated;

(vic) any transfer in a demerger, of a capital asset, being a share or shares held in an Indian company, by the demerged foreign company to the resulting foreign company, if—

(a) the shareholders holding not less than three-fourths in value of the shares] of the demerged foreign company continue to remain shareholders of the resulting foreign company; and

(b) such transfer does not attract tax on capital gains in the country, in which the demerged foreign company is incorporated ”

In both situations of business reorganization abroad between foreign companies, only transfer of shares of Indian company has been excluded. There is no mention about transfer of shares of the foreign company. There is no rationale not to extend this benefit to shares of a foreign company when the same is available to shares of an Indian company.

Thus, again capital gains arising on transfer of the shares of a foreign company have not been taken into account.

Tax Treaties – Article on capital gains.

All the DTAA entered into with other countries deal with taxation rights of capital gains. These provisions have been discussed in detail in section 4.15. None of the treaties deals with the situation of transfer of share of a foreign company or indirect transfer except in case of real estate companies.

Further, the provisions relating to indirect transfer are complex and cannot be implemented without a number of clarifications and exclusions. Otherwise, in its present form, such provisions could lead to outcomes which could not be the intended consequence of the legislature.

Thus, the above facts clearly show not only the absence of any evidence proving that these retrospective amendments are clarificatory in nature but also demonstrate lack of any legislative intent of taxation of capital gains arising on account of indirect transfer.

Recommendation:

As a matter of policy, Government should avoid anything which comes as a surprise or unexpected to the taxpayers. Indeed, as is prevalent in several countries, there is constitutional or statutory protection against retrospective application.¹⁵ Countries such as Brazil, Greece, Mexico, Mozambique, Paraguay, Peru, Venezuela, Romania, Russia, Slovenia and Sweden have explicitly banned retroactive taxation.

The Committee recommends that retrospective application of tax law should occur in exceptional cases, and exclusively to address types (i), (ii) & (iii) above. It should be confined to matters that are genuinely of a clarificatory nature, or to “protect” the tax base by countering highly abusive tax planning schemes, rather than “expand” the tax base.

In the Indian case, retrospective application of a tax law should occur only after exhaustive and transparent consultation with stakeholders who would be affected and in the rarest of rare cases.

The provisions relating to taxation of indirect transfer as introduced by the Finance Act, 2012 are not clarificatory in nature. These provisions, after the incorporation of their definitions as recommended separately in this Report, should be applied prospectively. This would better reflect global practice, as well as the principle of equity and probity in the formulation and implementation of commonly recognized taxation principles.

4.2 Meaning of the phrase “share or interest in a company or entity”

Submission by the Stakeholders

The term “interest” used in Explanation 5 of section 9(1)(i) is not defined. It may cover contractual arrangements which may not be in the nature of equity interest in a company. For instance, debt in a company may be considered as an interest of the lender in the company. In case of mutual funds where

¹⁵. For details see Annexe -5, which also includes associated correspondence with the Brazilian authorities.

investors pool their funds for downward investments by issue of units, such units may be considered as interest of the investor in the mutual fund. This may lead to unintended consequences as the intention was to tax transfer of ownership rights.

Analysis

It appears that the term "interest" has been used in respect of an entity like partnerships to cover rights like shares in a company. The term share and interest are *sue-generis* in nature and therefore the term "interest" should have a meaning similar to a share i.e. having rights associated with ownership, control or management of the entity.

Recommendations

It should be specified that the phrase "the share or interest in a company or entity registered or incorporated outside India" in Explanation 5 means and includes only such share or interest which results in participation in ownership, capital, control or management. Therefore, all other types including mere economic interest should not be contemplated within the ambit of Explanation 5.

4.3 Definition of "substantially"

Submission by the Stakeholders

Explanation 5 to section 9 (1)(i) of the Act provides for taxation of transfer of share on interest in a company or entity if such share or interest derives its value substantially from assets located in India. The term "substantially" has not been defined in the statute. It may lead to ambiguity and unnecessary litigation.

"Substantial" has been interpreted by the courts¹⁶ with reference to section 5 of Income-tax Act, 1922 as a word which had no fixed meaning and was an unsatisfactory medium for carrying the idea of some ascertainable proportion of the whole, and thus the classification being vague and uncertain, did not save the enactment from the mischief of article 14 of the

¹⁶ Shree Meenakshi Mills Ltd. v. Sri A.V. Visvanatha Sastri and anr, AIR 1955 SC 13; Suraj Mall Mohta & Co. v. A.V. Visvanatha Sastri and anr.,AIR 1954 SC 545.

Constitution. The word substantial may imply as that is not trivial but need not be major. Under section 2(32) and section 40A (2) the definition of "person having substantial interest in the company" uses a threshold of 20%. In the DTC Bill, 2010, a threshold of 50% was used.

Analysis

The term "substantially" may be interpreted in different ways. In terms of percentage of global assets, it may be any percentage such as 10, 20, 50, 80, etc. It may also be defined as an absolute value of assets in India, say, exceeding Rs 100 crore. It is, therefore, necessary to pin down a definition and there appears little reason to move away from the DTC Bill, 2010.

The word "substantially" is essentially linked to how the value of shares of a foreign company is derived. If a part of such value is derived, directly or indirectly, from assets located in India, then it should be substantial out of the whole value of shares for the purpose of Explanation 5. It does not say explicitly that total assets in India should be substantial out of the total global assets. Both phrases, deriving value substantially from assets in India, and assets in India being substantial as compared to the global assets, may be same where shares of a company derive their value directly from the physical assets of the company. Even where the shares of a company derive their value from their capacity to earn income in future (as in discount cash flow method), the same is derived from the intangible assets of the company being goodwill, trademark or other intangible assets. If both tangible and intangible assets owned, directly or indirectly, by the foreign company are included in assets, then the condition of shares of the foreign company deriving its value substantially from assets in India is the same as foreign company having, directly or indirectly, assets in India being substantial as compared to the global assets.

Another issue raised during discussion with stakeholders was what is implied by "assets located in India"; does it include assets owned by an Indian subsidiary outside India. For example, let us consider the following inward investment structure in India.

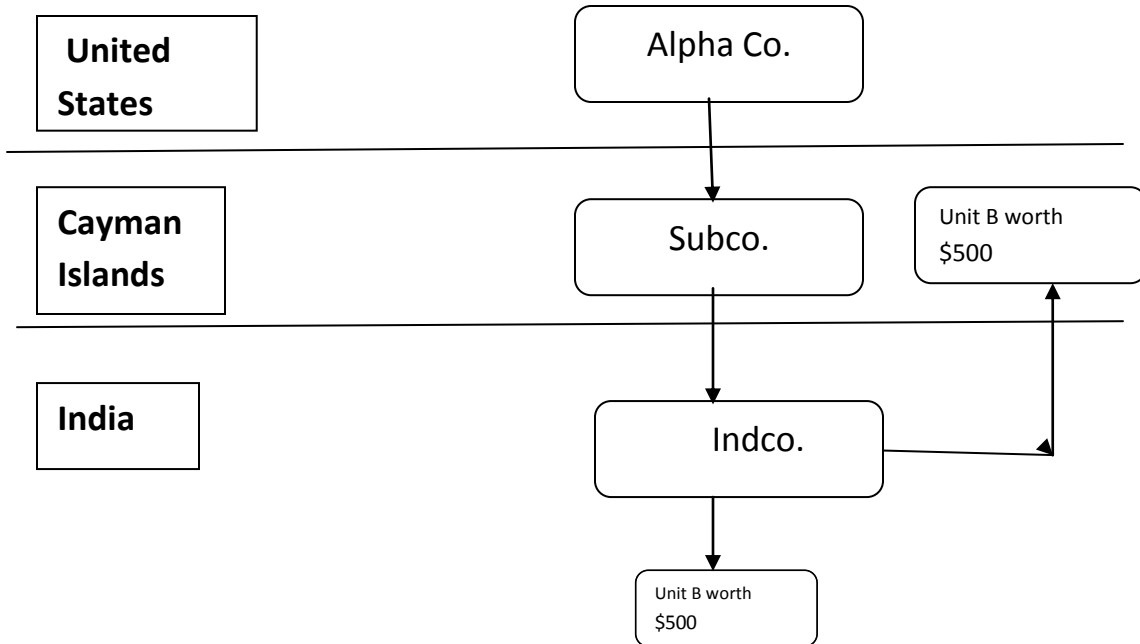

Alpha Co, a resident of USA, has a 100% subsidiary Subco in Cayman Islands, which has a 100% subsidiary Indco in India. Indco has two units, one in India worth Us\$100 and another abroad worth US\$ 500. For the purpose of determination of “substantial test”, what are the assets located in India and what should be the value of such assets.

One approach could be that shares of Subco derive their value from assets of the company Subco, which are nothing but shares of Indco. These shares of Indco have situs in India as being shares of an Indian company. Hence, it could be said that shares of Subco derive their value 100% from assets located in India. Here, we do not go beyond the shares of Indian company.

A second approach could be that shares of Subco derive their value from assets of the company Subco, which are nothing but shares of Indco. These shares of Indco derive its value of US\$100 from unit in India and US\$500 from unit abroad. Thus, shares of Subco derive their value indirectly of US\$100 from Indian unit and of US\$500 from unit abroad. Thus, the Indian assets are less than the 50% in value as compared to global assets. Hence, “substantial test” fails and Explanation 5 may not be applicable in this case.

The basic objective of the tax provisions for indirect transfer is to tax transfer of assets located in India if transferred indirectly. In the present example, if shares of Subco are transferred directly, then entire capital gains is taxable in India. If shares of Subco are transferred, instead of Indco, then going by the

second approach, nothing would be taxable in India. Whereas the first approach would result in the same taxation as in the case of direct transfer.

It is recommended to follow the first approach.

Recommendations

The word “substantially” used in Explanation 5 should be defined as a threshold of 50 per cent of the total value derived from assets of the company or entity. In other words, a capital asset being any share or interest in a company or entity registered or incorporated outside India shall be deemed to be situated in India, if the share or interest derives, directly or indirectly, its value from the assets located in India being more than 50% of the global assets of such company or entity. This has been explained through the above illustration.

4.4 Meaning of the phrase “directly or indirectly”

Submission by the Stakeholders

There is no clarity as to how “value” of shares of a foreign company is derived directly or indirectly from assets located in India.

Analysis

The phrase “directly or indirectly” has been frequently used in OECD and UN Model Conventions, particularly Article 13. This has been interpreted as “look through” approach. For example, when it is said that an enterprise is controlled, directly or indirectly, by residents of a contracting state, it implies ignoring all intermediaries who come between the enterprise and residents, and seeing whether residents are owner of the enterprise or not.

The shares of a company are valued based on the assets of the company. The assets include property of any kind i.e. land, building, shares, intellectual property rights etc. The assets, being shares in a second company, in turn will derive their value from assets of the second company. Thus, the shares of the first company, having shares in a second company, will derive their value indirectly from the assets of the second company.

Let us consider a multi tier structure as shown below. Let us presume that the companies (other than Ind Co and Z Ltd) do not have any asset except investment in downward subsidiaries. Ind Co has assets worth USD 100\$ and Z Ltd has USD 50\$.

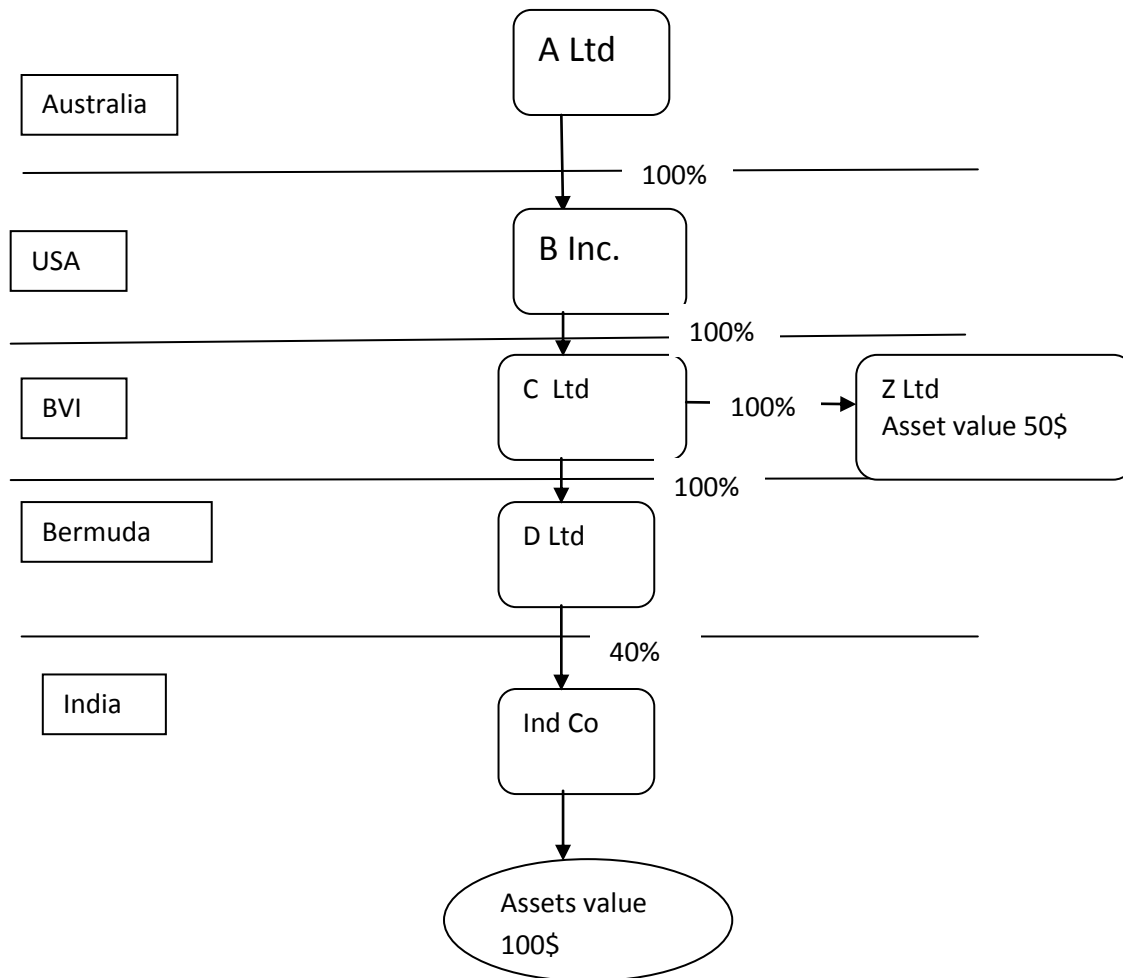

In this case, shares of A Ltd derive their value directly from the value of shares of B Inc, which derive their value from shares of C, which in turn derive their value from shares of D Ltd. and Z Ltd. The shares of D Ltd derive their value from 40% shares of Ind Co, which, in turn, derive their value from assets worth US\$ 100 in India. Thus, shares of A Ltd, B Ltd, C Ltd derive their value indirectly from assets of Indco and Z Ltd. Shares of D Ltd derive their value from assets of Indco. In quantitative terms, shares of A Ltd derive their value indirectly from assets located in India worth US\$ 40 (US\$100@40%) and assets located in BVI company Z Ltd worth US\$ 50.

Recommendations

In view of the above, the phrase “directly or indirectly” may be clarified to represent “look through” approach. The illustration provided above is an example of the look-through approach. It implies that, for determination of value of a share of a foreign company, all intermediaries between the foreign company and assets in India may be ignored.

4.5 Meaning of the word “value” and point of time for valuation

Submission by the Stakeholders

Explanation 5 to section 9(1)(i) refers to the value of share or interest in a foreign company or entity but there is no clarity in respect of :

- Whether it refers to book value or fair market value
- Whether gross assets are to be considered or net assets (both assets and liabilities)
- Whether it includes physical assets as well as intangible assets
- At what point of time value is to be determined.

Analysis

Considering the context and objective of the amendment, it is obvious that, what is intended is the fair market value (FMV) and not the book value. Such value is to be derived from the FMV of the assets of the company or its subsidiaries. The assets of the company should include both tangible as well as intangible assets. The value of any share is based on net worth of a company, hence it is logical that both assets as well as liabilities be considered.

The text of the amendment suggests that value should be determined at the point of disposal of shares of the foreign company. However, in the DTC, the value is considered at that point of time during the previous 12 months preceding the date of disposal of shares, which yields the highest value during that period.

The Parliamentary Standing Committee on Finance, after examination of the DTC Bill 2010, found that the criterion for computing FMV of assets at its

highest point during 12 months preceding the transfer date was onerous. The Committee therefore recommended that it would be fair if the valuation could be made on a particular date like the balance sheet date immediately preceding the date of transfer.

However, there may be substantial activity of assets acquisition and disposal between the date of last balance sheet and the date of transfer. Hence, it may not reflect the correct value of shares.

Thus, taking value at any time preceding 12 months is an onerous compliance burden on the taxpayer and taking value at last balance sheet date may not reflect the actual value on the date of transfer, and thus may provide scope for manipulation. A preferable approach would be that FMV of assets may be determined based on the last balance sheet date of the foreign company and appropriate adjustments may be made for significant change/activity, if any, between the last balance sheet date and the date of transfer.

Recommendations

In view of the above, it may be clarified that for the purposes of Explanation 5 to section 9(1)(i), –

- (i) the value refers to fair market value as may be prescribed;**
- (ii) the value is to be ascertained based on net assets after taking into account liabilities as well;**
- (iii) for determination of value, both tangible assets as well as intangible assets are to be considered; and**
- (iv) the value is to be determined at the time of the last balance sheet date of the foreign company with appropriate adjustments made for significant disposal/acquisition, if any, between the last balance sheet date and the date of transfer.**

4.6 Concern of small shareholders

Submission by the Stakeholders

The apparent objective of the amendment to section 9 is to bring into the tax net, indirect transfer of assets situated in India. But the scope of the

amendment is so wide that, even if a single share (constituting less than 1% of total shareholding) of a foreign company having substantial assets in India is transferred outside India, then the gains arising on such a transfer, would be taxable in India. That would lead to undue hardship considering the fact that a single shareholder may not be in the know of all the global assets of the company.

Analysis

The Standing Committee has recommended that transfer of small shareholdings in a foreign company should not be subject to undue hardship as it does not result in the transfer of a controlling interest in the Indian assets.

It was, therefore, suggested to exempt small shareholdings of the foreign company from taxation in India. But there are several issues in defining small shareholding as discussed below.

- Threshold to be based on holding or transfer of shares

Concerns of small shareholders can be taken care of either by excluding the persons holding less than a specified percentage from the purview of indirect transfer or by excluding persons transferring a quantum of shares of the foreign company below a specified percentage of holding during a period (say 12 months). The latter may, however, create problems in implementation.

For example, a non-resident person X has 60% shares of a foreign company which has substantial assets in India as on 31.03.2013. He sells these shares during the year 2013-14 as under –

On 1.7.2013 10% shares to A

On 1.10.2013 10% shares to B

On 1.1.2014 10% shares to C

If a threshold of 26% of shares transferred during the preceding 12 months is specified so that any transfer of shares above that limit is taxable, then in the above example, total sale during a year is more than the threshold but it would be impossible for buyer A to know as on 1.7.2013 whether the seller is going to exceed the threshold or not. Hence, such a threshold, based on a cumulative approach, is difficult to implement in practice.

On the other hand, if the threshold of 26% of total holding at any time during 12 months preceding the date of transfer is considered, then it is easier to implement. But it may cause undue hardship since transfer of one share by such major share holder becomes taxable. However, this is taken care of in the case of listed companies since they will be exempted. The transfer of small holdings does not happen in unlisted companies and, for listed companies, a separate exclusion is being recommended as discussed below in section 4.7 of this Report.

- Threshold to be based on controlling interest in Indian assets, immediate foreign holding or any foreign holding company

So far, only holding in the foreign company having underlying assets in India were considered. But in all cases, it does not translate into a controlling interest in Indian assets. For instance, consider the following inward investment structure-

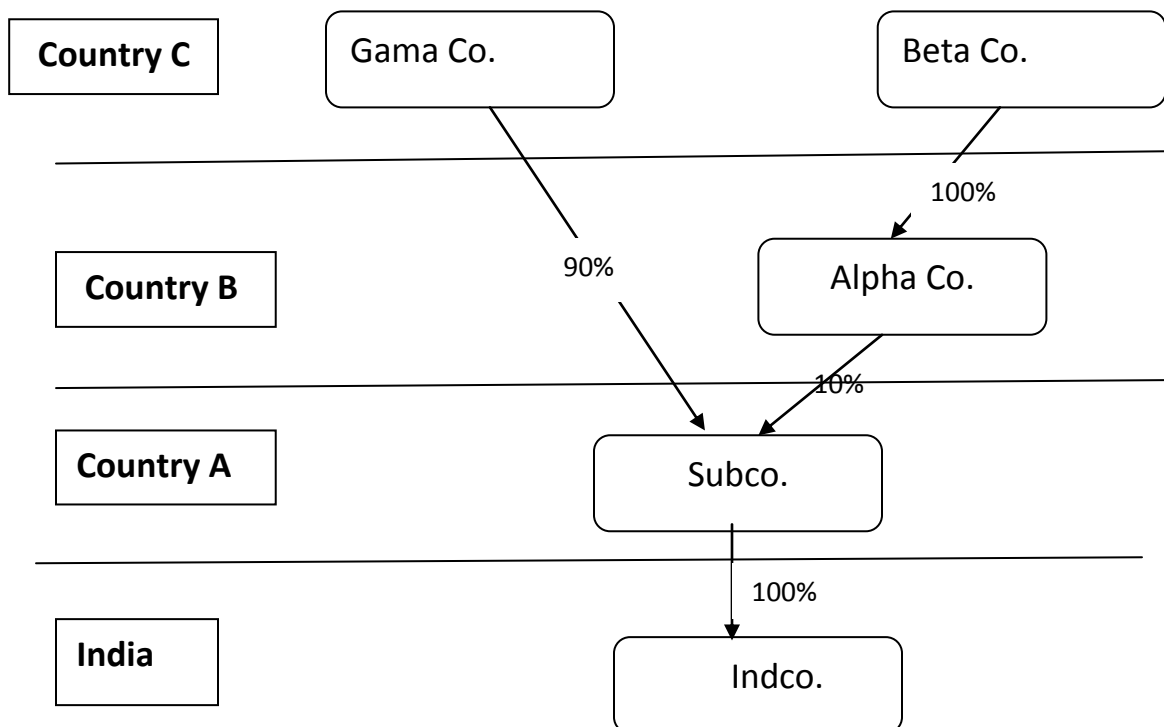

In the above illustration, Alpha Co owns 10% shares in Subco but it is the only asset it has. The Subco has all its assets in India alone. Thus shares of Alpha Co derive their value wholly from assets in India. Hence any transfer of shares of Alpha Co would be covered by the provisions of the Explanation 5. When Beta Co transfers its 100% shareholding to some third party, it would cross the threshold (say 26%) of holding and would be liable to tax in India. But this is not the objective of indirect transfer provisions, as it amounts to transfer of only 10% of interest in Indian assets held by the non-resident company Subco. Secondly, if all the 10% shares held by Alpha Co are transferred to some third party, then it would be less than the threshold and it would not be taxable as indirect transfer.

It is therefore necessary to specify the threshold only in the case of immediate holding company while, for up-tier holding company, it should be worked out in a proportionate manner. For instance in the above illustration, the holding of Alpha in the immediate holding company is 10%; and the holding of Beta Co in immediate holding company is also 10% and not 100%.

- Threshold limit as percentage of total voting power or share capital

The basic objective of indirect transfer provisions is to tax transactions which result in

(i) transfer of assets located in India indirectly; or

(ii) transfer, directly or indirectly, of controlling interest in the company or entity having direct underlying assets in India (hereinafter referred as immediate holding company) which amount to indirect transfer of partial interest in Indian assets.

Transaction at (i) above is possible when 100% of shares of the immediate holding company are transferred directly or indirectly. Transaction at (ii) is possible only when the controlling interest in the immediate holding company is transferred.

The controlling interest in a company or entity vis-à-vis the share capital or interest in an entity depends on the laws of each country. In India, under Companies Act, a special resolution can be blocked only by a person having 26% or more voting power or share capital. Hence, on a conservative side, 26% of the total voting power may be considered as the threshold.

Recommendations

In view of the above, it is recommended that where share or interest in a foreign company or entity derives, directly or indirectly, its value substantially from assets located in India, then transfer of such share or interest in the company or entity outside India would not be subject to tax in India under section 9(1)(i) of the Act, if,

- (i) in case such company or entity is the immediate holding company, the voting power or share capital of the transferor along with its associated enterprises in such company or entity does not exceed 26% of total voting power or share capital of the company or entity during the preceding 12 months; or**
- (ii) in other cases, the voting power or share capital of the transferor in such company or entity along with its associated enterprises during the preceding 12 months does not exceed such percentage which results in 26% of total voting power or share capital of the immediate holding company having underlying assets in India.**

4.7 Concern of listed foreign company

Submission by the Stakeholders

In case of a foreign company having substantial assets in India which is listed on a stock exchange, frequent trading of shares takes place on the exchange everyday. It is impossible to tax all such transactions in India. Since the objective of the amendment was to tax indirect transfer through paper companies, a listed company should not be considered as a shell or conduit company. It was therefore suggested to exempt listed companies from the purview of section 9(1)(i) of the Act.

Analysis

The Standing Committee has recommended that foreign companies listed on a stock exchange should be kept outside the purview of indirect transfers. However, a number of stock exchanges are not appropriately regulated and mere listing in such exchanges does not mean that a company is actively engaged in substantial economic activities of that country.

However, a company which is listed in a well regulated stock exchange and where shares of a company are regularly traded, cannot be considered to be a conduit company established for the purpose of avoidance of tax.

As discussed earlier in section 4.6 of this report, a person holding substantial interest in a foreign company may sell a small shareholding on a recognized stock exchange overseas and such transfer would be subject to capital gains tax in India unless a specific exclusion is provided in law.

The concept of recognized stock exchange has been used in RBI circulars¹⁷ in respect of direct investment by residents in Joint Ventures (JVs)/ Wholly Owned Subsidiary (WOS) abroad. Similar concept may be used to specify recognized stock exchanges for the purposes of taxation of indirect transfer.

The SEBI takeover code regulations¹⁸ specify “frequently traded shares” as

“frequently traded shares” means shares of a target company, in which the traded turnover on any stock exchange during the twelve calendar months preceding the calendar month in which the public announcement is made, is at least ten per cent of the total number of shares of such class of the target company:

Provided that where the share capital of a particular class of shares of the target company is not identical throughout such period, the weighted average number of total shares of such class of the target company shall represent the total number of shares;”

The same definition may be adopted to identify frequently traded shares.

Recommendations

In view of the above, the Committee recommends that exemption may be provided to a foreign company which is listed on a recognized stock exchange and its shares are frequently traded therein. The terms “frequently traded” and “recognized stock exchange” may be

¹⁷ RBI, Master Circular No 11/2012-13 dated 02 July 2012. See para 6(1)(iii).

¹⁸ SEBI Notification dated 23 Sept.2011 under SECURITIES AND EXCHANGE BOARD OF INDIA (SUBSTANTIAL ACQUISITION OF SHARES AND TAKEOVERS) REGULATIONS, 2011

defined as in the SEBI guidelines and RBI regulation on overseas investments by residents respectively.

4.8 Tax neutrality in cases of business reorganization abroad

Submission by the Stakeholders

Internationally, it is an accepted principle that business reorganizations within a group are tax neutral i.e. not subject to tax. This principle has been followed in India as well. Section 47 provides exemption to the following reorganizations –

- (i) Demerger or amalgamations between companies where the resulting company or amalgamated company is in India
- (ii) Demerger or amalgamation between foreign companies in respect of transfer of shares of Indian companies, provided such transfer is not taxable in their home jurisdictions.

As taxation of shares of foreign companies was not anticipated in the past, there is no specific provision in the Act that addresses this aspect. In the absence of such exclusion, capital gains arising on intra-group transfer of shares of foreign company having underlying assets in India will be taxable. It was therefore suggested to specifically exclude business reorganizations within a group from the taxation of an indirect transfer.

Analysis

The Standing Committee has also recommended that exception may be provided to intra group restructuring outside India.

As the business reorganization within a group does not result in any real income, such transfer whether in India or outside should be tax neutral. However, there should be sufficient safeguards to prevent misuse of such exemption by way of continuity of ownership.

Section 2(1B) defining “amalgamation”, clause (vic) of section 47 relating to demerger between foreign companies provide for continuity of ownership of at least three fourth in value of shares.

Recommendations

Transfer of shares or interest in a foreign company or entity under intra group restructuring may be exempted from taxation subject to the condition that such transfers are not taxable in the jurisdiction where such company is resident.

For this purpose, intra group restructuring may be defined as

(i) amalgamation or demerger as defined under the Act subject to continuity of at least three fourth ownership; or

(ii) any other form of restructuring within the group (associated enterprises) subject to continuity of 100% ownership.

4.9 Concerns of Foreign Institutional Investors

Submission by the Stakeholders

An FII is an institution established or incorporated outside India which proposes to make investments in India in securities listed on recognized stock exchanges. FIIs are regulated by Securities Exchange Board of India (SEBI) through the SEBI (Foreign Institutional Investors) Regulation, 1995 read with instructions and circulars issued by SEBI from time to time. An FII is also allowed to issue or otherwise deal in Offshore Derivative Instruments/Participatory Notes (PNs) against underlying Indian securities if it satisfies the following conditions:

- (a) such offshore derivative instruments are issued only to persons who are regulated by an appropriate foreign regulatory authority;
- (b) such offshore derivative instruments are issued after compliance with 'know your client' norms.

There are further regulatory and reporting requirements enforced by SEBI from time to time. The reports to be submitted by FIIs to SEBI have to incorporate the following undertaking:

"We undertake that the beneficial owner and the person(s) to whom the Offshore Derivative Instrument is issued is in compliance with Regulation 15A of SEBI (FII) Regulations. We also undertake that the

KYC compliance norms have been followed for the beneficial owner of the Offshore Derivative Instrument”.

Thus, the investment structure in case of a typical FII is a multi-tier structure consisting of individual investors located in various jurisdictions, participatory note holders, feeder funds, with the main FII being registered with SEBI. The FII is the entity taxable in India as per its domestic laws read with treaty provisions. All non-resident investors in an FII, directly or indirectly, will have underlying assets in India, and consequently transfer of investment by these non-resident investors outside India may lead to tax liability in India after amendment of section 9 of the Act. Such taxation may arise at every upper level of investment in the FII structure leading to multiple taxation of the same income which is subject to tax in India in the hands of the FII. It is, therefore, necessary to exclude all investors above the level of FII from the tax net in respect of investments by an FII in India.

Analysis

It is seen that broadly there are two types of structures adopted for FII investment in India i.e. direct investment and synthetic investment. This is explained diagrammatically in **Annexe-4**. In both the structures, the taxable entity is FII or Sub FII which is registered with SEBI and which makes investments in India in its own name. It is this FII or Sub FII which is the taxable person in respect of gains or losses in India. Thus, gains or losses as per investments shown as leg 3 of direct investment and leg 4 of synthetic investment is taxable in India, as has been elaborated in the first report of this Committee on GAAR.

Under indirect transfer provisions that is the focus of this second report, transfer/redemption of investments occurs at leg 1 or leg 2 of direct investment and leg 1, leg 2 or leg 3 of synthetic investment. Unless legally excluded, this may also be taxable in India. This may lead to multiple taxation of the same income, particularly where the frequency of transfers is likely to be high at all legs.

Recommendations

In view of the above, it may be clarified through a circular that the investments made by a Foreign Institutional Investor (FII) as per regulation of the SEBI are subject to tax in India in the hands of FII.

Taxation of non-resident investors investing, directly or indirectly, in the FII may lead to double or multiple taxation. It is, therefore, clarified that where

(i) a non-resident investor has made any investment, directly or indirectly, in an FII; or

(ii) the investment made by an FII in India represents, directly or indirectly, the underlying assets of investment by a non-resident,

then such non-resident will not be taxable in India on account of the provisions of section 9(1)(i) of the Act in relation to investments made by the FII in India.

4.10 Concern of Private Equity Investors

Submission by the Stakeholders

One industry concern was that the provision would permit Indian authorities, subject to the statute of limitations (for example six years for reopening of an assessment), to assert tax against any non-Indian investor who sold shares of a non-Indian fund investing in India. The industry's concern would be even greater if tax were asserted against a non-Indian investor who held only a small interest in a publicly-available fund, even one investing exclusively in India that held only small, non-controlling interests (e.g. less than 10 per cent) in individual Indian companies.

Although the indirect transfer provision apparently is intended to address situations in which a non-Indian investor sells a controlling interest in a non-Indian holding company that owns a controlling interest in an Indian company, the provision is not so limited. The simplest way to address this concern would be to state precisely those transactions that the provision is intended to cover.

Alternatively, a list of excepted transactions could be provided. One such alternative, a de minimis exception applicable to the fund itself, could be crafted based upon the 20 per cent investment limit that would apply to foreign institutional investors. Another alternative approach would be to

except from the provision's application transfer of shares of publicly available investment funds.

The investment fund industry is unique in that (1) the typical fund values its assets daily and (2) the typical fund's interests (e.g. shares) generally are purchased and sold each day based upon the fund's net asset value. Uncertainty regarding the tax treatment of a fund's investments creates uncertainty regarding fund asset values and the price at which the fund's interests should trade.

The investment fund industry's need for tax certainty illustrates quite clearly the negative impact on investor confidence of legislation that applies, whether retroactively or prospectively, to existing investments. Funds must evaluate constantly the valuations of their portfolio securities and the benefits of continuing to hold them. The possibility of incurring unexpected tax can affect valuation consideration and reduce investor demand for Indian securities. Reduced demand, in turn, could reduce securities prices and harm Indian companies and their investors.

Analysis

In the case of non-resident investors making investment in unlisted securities of Indian companies through a fund or fund pooling vehicle registered or constituted outside India-

(a) Where investors are holding instruments in the fund or fund pooling vehicle that do not carry any ownership rights, there would not be any taxability as regards indirect transfer since interest in the company or entity akin to ownership rights (like share) does not exist.

(b) In case of investors holding instruments which carry ownership rights, if the Indian investment/assets of the fund or fund pooling vehicle constitute a substantial part of such entity's total assets, then transfer of such holding outside India would not be subject to tax in India if the holding of the transferor in such entity does not exceed a threshold of 26% as suggested above.

(c) In case the Indian investment/assets of the fund or fund pooling vehicle are not substantial, then, the condition of "substantially" in Explanation 5 would anyway not be attracted and hence indirect transfer of such instruments of fund or fund pooling vehicle would not be taxable.

Recommendations

The recommendations suggested above in respect of “interest”, small shareholding, business reorganizations, listed companies etc. should, in totality, address the concerns of private equity (PE) investors. To reiterate, private equity investors would be outside of the coverage of taxation of indirect transfer where –

- (i) the investment by the non-resident investor in a PE fund is in the form of units which do not results in participation in control and management of the fund;**
- (ii) the investor along with its associates does not have more than 26% share in total capital or voting power of the company,**
- (iii) the investee company or entity does not have more than 50% assets in India as compared to its global assets;**
- (iv) the investee company is a listed company on a recognised overseas exchange and its shares are frequently traded,**
- (v) the transfer of share or interest in a foreign company or entity results due to reorganization within a group.**

4.11 Implication of amendment to the definition of “transfer”

Submission by the Stakeholders

The definition of the term “transfer” has been widened to include various activities which were hitherto not considered as transfer at all. DTC 2010 did not have any broadening of the definition of transfer. Further, internationally, other countries appear not to have included such a broad definition of transfer. In this light specific problems highlighted by Stakeholders are taken up and discussed below.

For instance, mortgage or pledging of property, or introduction of a new partner in partnership firm may be considered to be disposal of, or parting with, an interest in property or firm, as the case may be, and consequently may be subject to tax.

As per the new explanation to the definition of the term “transfer”, any indirect disposal or parting with a share of an Indian company, shall be deemed to be a transfer notwithstanding that such disposal is flowing from the transfer of a share or shares of a foreign company registered or incorporated outside India. Consequently, it shall be subject to taxation in India. Although such transfers may not be liable to taxation under explanation 5 to section 9(1)(i) of the Act. Moreover, there is no clarity on the computation of capital gains and subsequent step up of the cost of acquisition of capital assets.

Analysis

The amendment to section 9(1)(i) and definition of term “transfer” has resulted in taxation of transfer of shares of a foreign company having underlying assets in India in two ways i.e.

- (i) to tax capital gains arising through **indirect disposal** of assets located in India; and
- (ii) to tax capital gains on transfer of shares of a foreign company, where underlying assets of such foreign company are substantially in India, thereby implying that the **situs of the shares of the foreign company** is in India.

This is explained through the following illustration.

Consider a cross-border multi-tier investment structure as shown below. A Ltd is a company incorporated in the US. B Ltd is its 100% subsidiary in the Cayman Islands representing \$100m investment of A Ltd. The companies C Ltd., D Ltd. and E Ltd. are its 100% subsidiaries in India, Australia and Singapore respectively. They represent \$ 5m investment in India, \$ 50m investment in Australia and \$ 45m investment in Singapore. C Ltd. constitutes only 5% of total (global) assets of B Ltd. in terms of fair market value.

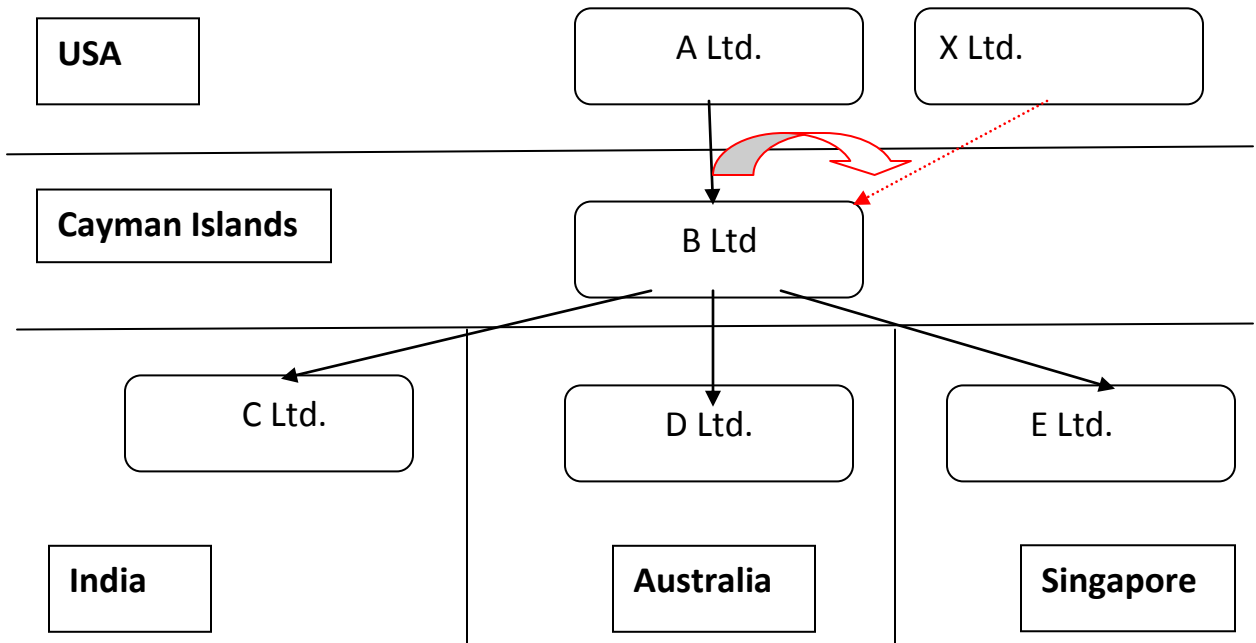

A Ltd. sells 100% of its shares in B Ltd. to a company X Ltd. for \$ 200m.

Under explanation 5 of section 9(1)(i), shares of B Ltd. cannot be deemed to be situated in India as substantial assets of B Ltd. are not located in India.

However, under the definition of "transfer", it may be said that shares of C Ltd. (the Indian company) have been disposed of indirectly and therefore this amounts to a transfer of shares of C Ltd., the Indian company. Such transfer of Indian company C Ltd. has resulted in income arising indirectly to A Ltd. by way of capital gains on the transfer of shares of B Ltd. Hence, A Ltd's indirect income is liable to tax under section 9(1)(i) of the Act. This is elaborated through the provisions of section 9(1)(i) as under-

*"9(1)(i) all income **(Capital gains on sale of shares of B Ltd.)** accruing or arising, whether directly or indirectly **(because of disposal of assets in India)**.*

*-through **(by reason of)** the transfer **(indirect disposal of assets in India)** of a capital asset **(shares of C Ltd.)** situated in India"*

The sequence of reasoning as to why income is taxable in India may be viewed as follows :

- (i) The shares of C Ltd., being Indian company, are capital assets and situated in India.*
- (ii) Such shares of C Ltd. are indirectly disposed of by way of sale of shares of B Ltd. outside India. Hence they constitute a transfer of shares of C Ltd.*
- (iii) By reason of transfer of shares of C Ltd., an indirect income has arisen to A Ltd. by way of capital gains.*
- (iv) This indirect income attributable to the transfer of an Indian asset should comprise that part of the total capital gains (\$100m) which is attributable to the value of the Indian asset. This is 5% of the total capital gains, which is \$ 5m.*

Thus, out of a total capital gains of \$ 100 m, \$ 5 m would be taxable in India. There would be no separate computation of capital gains on the transfer of capital asset being shares of C Ltd. as its owner did not receive any consideration.

The real problem is how to define indirect disposal of assets. For instance, consider where all the shares of B Ltd are not sold but only

- (i) 1% shares are sold; or
- (ii) 51% (being controlling interest) shares are sold.

In case (i), can it be said that shares of C Ltd have been transferred or 1% interest in shares of C Ltd. has been transferred? Does it require that controlling interest in B Ltd should be transferred in order to deem indirect transfer of controlling interest in shares of C Ltd? Even in change of controlling interest, how would the capital gains be computed?

As a company is a separate legal entity, the shareholder is not the legal owner of the assets of the company. It cannot be said that 1% transfer of shares of a company amounts to transfer of 1% interest in all assets of the company and hence, it comprises an indirect disposal. Only in the case of 100% transfer of shares of a company, it may be concluded that the **assets of the company** are being disposed of indirectly.

Recommendations

As the provisions of section 9(1) (i) read with Explanation 5 of the Act specifically deal with transfer of shares of a foreign company having underlying assets in India, the general provisions of section 2(47) relating to transfer should not be applied on a stand alone basis.

4.12 Levy of interest and penalty

Submission by the Stakeholders

Article 20(1) of the Constitution provides certain safeguards as regards a retrospective amendment by providing that no person can be convicted for any offence except for a violation of a law in force at the time of action charged an offence, nor be subjected to a penalty greater than that which might have been inflicted under the law in force at the time of offence.

First of all, there should not be any retrospective amendment adversely affecting the liability of a taxpayer. The Madras High Court held¹⁹ that, if taxes were payable due to a retrospective amendment, interest for shortfall of taxes is not leviable as the taxpayer can estimate his current income and related tax liability only based on the law that exists at the time of payment of advance tax and cannot visualize any further amendment in the law.

Therefore, if retrospective amendments are nevertheless made, then it is unfair and unjustified to levy interest on any additional tax demanded from taxpayers and, in no circumstances, penalty for any default should be levied as the taxpayer complied with the law as actually existed at the earlier point of time prior to the retrospective change.

Analysis

The Central Board of Direct Taxes (CBDT) issued an order²⁰ indicating the class of incomes or class of cases in which reduction or waiver of interest under section 234A, 234B or 234C²¹ as the case may be, could be considered

¹⁹ Revati Equipment Ltd (2007), 298 ITR 67 (Madras).

²⁰ F.No. 400/234/95-IT(B), dated 23rd May, 1996

²¹ Charging of interest for non-filing of return of income in time, short payment of advance tax, deferment in payment of advance tax.

by the Chief Commissioner of Income-tax and Director General of Income-tax. Clause (d) of para 2 of the said order read as under :

"Where any income which was not chargeable to income-tax on the basis of any order passed in the case of an assessee by the High Court within whose jurisdiction he is assessable to income-tax, and as a result, he did not pay income-tax in relation to such income in any previous year and subsequently, in consequence of any retrospective amendment of law or as the case may be, the decision of the Supreme Court, in his own case, which event has taken place after the end of any such previous year, in any assessment or re-assessment proceedings the advance tax paid by the assessee during the financial year immediately preceding the relevant assessment year is found to be less than the amount of advance tax payable on his current income, the assessee is chargeable to interest under section 234B or section 234C and the Chief Commissioner or Director General is satisfied that this is a fit case for reduction or waiver of such interest."

In partial modification²² of this para of the Order, the CBDT decided that there shall be no condition that the decision of the High Court or the Supreme Court, as referred to therein, must be given in the assessee's own case.

Thus, the CBDT also recognized that penal interest should not be levied in cases of retrospective amendments. However, this waiver is limited only to interest chargeable under sections 234A, 234B and 234C. It does not cover interest under section 201(1A)²³ of the Act. Once penal interest is not leviable, then there is no justification for levy of penalty.

Recommendations

In view of the above, the CBDT should clarify through a circular that, in all cases where demand of tax is raised on account of retrospective amendment relating to indirect transfer u/s 9(1)(i) of the Act then no interest under section 234A, 234B, 234C and 201(1A) of the Act be charged in respect of that demand so that there is no hardship caused to the taxpayer by going through the process of waiver by CCIT. Moreover, in such cases, no penalty proceedings should be initiated in respect of such taxes.

²² Order F. No. 400/234/95-IT(B), dated 30-1-1997.

²³ Levy of interest for short or no deduction of tax or after due date, late payment of tax.

4.13 Proportionality of taxation

Submission by the Stakeholders

It has been argued by the Stakeholders that where shares of a foreign company having underlying assets in India are deemed to be situated in India and consequently, capital gains arising on sale of such shares are taxed in India, then, only gains attributable to assets in India should be taxable. In other words, the taxable gains in India should be that proportion of the total gains which Indian assets bear to the global assets. In DTC Bill, 2010, the same concept of proportionality has been followed.

As an illustration, consider the structure mentioned in para 4.12 above. Let us assume, the India assets of the company B Ltd are 55% (not 5% in that example), Australian assets constitute 25% and Singapore assets 20%. Thus, B Ltd has substantial assets in India. If shares of B Ltd are transferred and subject to tax in India, then, gain would include profits attributable to investments in Singapore and Australia as well. India should not have any right of taxation of profits attributable to assets located outside India.

Analysis

There are basically three approaches that can be followed in this regard-

- (1) have a high threshold and tax full gains
- (2) have a lower threshold and tax proportionately, or
- (3) have an appropriate threshold keeping in mind the need for investment capital and tax proportionately.

In cases of real estate companies, the OECD MC and UN MC provide a threshold of 50% of underlying assets and do not provide for proportional taxation. On the other hand, countries like Israel have no threshold and tax gains on indirect transfer based on proportionality.

However, there is no particular reason to tax 100 per cent of the gains just because the foreign company's majority assets are located in India. Indeed such an approach would be directly contrary to foreign investment in India.

Therefore, it would be appropriate to use a 50% threshold as recommended in the OECD MC or UN MC guidelines and, at the same time, to tax gains proportionately. This also reflects the position taken in the DTC Bill, 2010.

Recommendations

In view of the above, a threshold of 50% of underlying assets in India should be adopted for taxation of capital gains on indirect transfer, together with a proportional basis of taxation of the same.

4.14 Cascading effect on dividend taxation in multi-tier structure abroad

Submission by the Stakeholders

Section 9(1)(i) of the Act provides that income through or from any asset or source in India shall be deemed to accrue or arise in India. In case of a foreign company having substantial underlying assets in India, the shares of such company are deemed to be situated in India. Besides capital gains on transfer of such shares, dividend received in respect of such shares may also be treated from a source situated (deemed) in India and consequently taxable in India. In case of a multi-tier structure, it may lead to a cascading effect.

For illustration, let us consider the structure shown below.

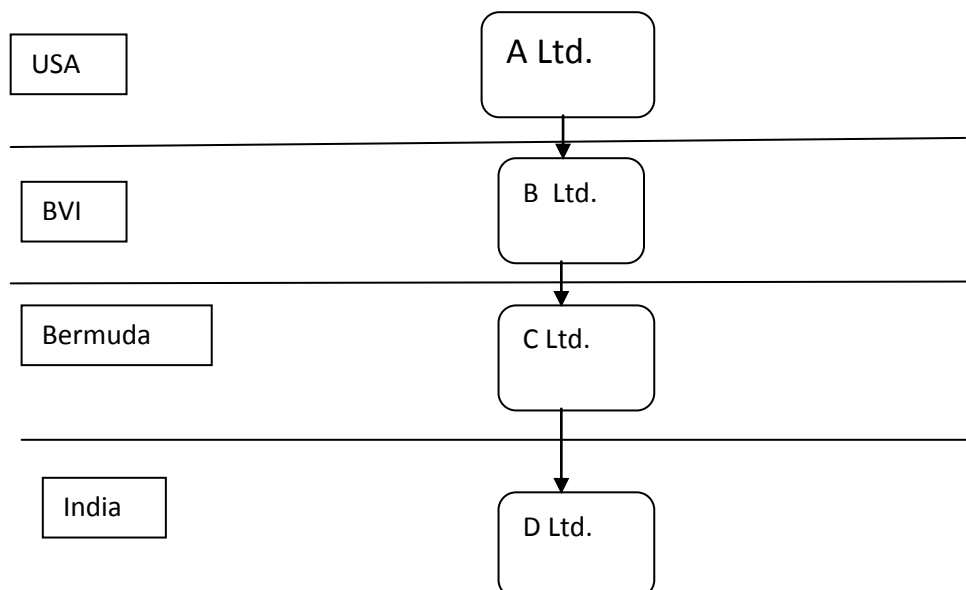

Here, all three foreign companies have 100% underlying assets in India. Hence, as per explanation 5 of section 9(1)(i), shares of all these companies shall be deemed to be situated in India. The dividend payable by C Ltd. may be treated as if from a source located in India, hence deemed to accrue or arise in India. Similarly, dividend payable by B Ltd. and A Ltd. could also be taxable in India.

Analysis

Apparently the intention to amend section 9(1)(i) by insertion of explanation 5 was to tax any indirect transfer of capital asset situated in India by way of transfer of controlling assets outside India. This was achieved by deeming such assets, deriving their value from assets located in India, to be situated in India. Applicability of such provisions to dividend income should be an unintended consequence.

Recommendations

In view of the above, dividend paid by a foreign company shall not be deemed to accrue or arise in India under section 9(1)(i) read with Explanation 5.

4.15 Conflicts with the tax treaties (DTAAs) of India

Submission by the Stakeholders

India has entered into DTAAs with a number of countries. The DTAAs provide the right of taxation, inter alia, in respect of capital gains arising in the source country. Many DTAAs (e.g. the US, UK) provide the right of taxation to a source country as per its domestic law. However, by amendment of domestic law, India has expanded its tax base unilaterally which may not be respected by all treaty partners, possibly resulting in double taxation.

In triangular cases, where all three countries involved (i.e. country of residence of seller, country of residence of the foreign company, and India where underlying assets are situated) may tax the same income arising from the transfer of shares of the foreign company. This may result in multiple taxation without tax relief in any jurisdiction.

In some cases, there would be treaty interpretation issues as the right of taxation to the source country is given in specific circumstances. For instance, on alienation of shares of a company, which is resident of a country, the country has the right of taxation of capital gains arising from such transfer. The language of the treaties, by and large, cover only a direct transfer. Whether indirect transfer of shares of an Indian company are covered under the treaty or not, remains a question.

Whether the definition of the term "transfer" used in domestic law can be used to interpret the term "alienation" used in tax treaty is another issue. The domestic law uses the phrase "through transfer of a capital asset" which is much wider than the phrase used in a DTAA i.e. "from alienation of shares of a company". Also, the word "through" is different from the word "from", as explained in the first Report on GAAR.

Analysis

The then Finance Minister in his speech in Parliament on 10th May, 2012, at the time of announcement of Government amendments stated that the retrospective amendments related to indirect transfer shall affect mainly transactions in non-treaty countries and where they lead to double non-taxation.

The DTAAs entered into by India with other countries have different formulations for taxation rights on capital gains. These may be divided, mainly, into four categories-

- (i) India has right of taxation of all capital gains as per its domestic law (e.g. US and UK);
- (ii) India has right of taxation of capital gains arising on alienation of shares of an Indian company (in most treaties);
- (iii) India has right of taxation of capital gains arising on alienation of shares of an Indian company only if the transferee is a resident of India (e.g. Netherlands)
- (iv) India does not have right of taxation of capital gains arising on transfer of shares of an Indian company (e.g. Mauritius, Singapore, Cyprus)

Thus, these amendments would affect only those investors that come from a jurisdiction with which India does not have a tax treaty; or, where there is a

tax treaty, India has right of taxation as per its domestic law under the treaty; or, India has right of taxation on alienation of shares of an Indian company.

To delineate the concerns of Stakeholders, let us consider the following example-

Illustration -I

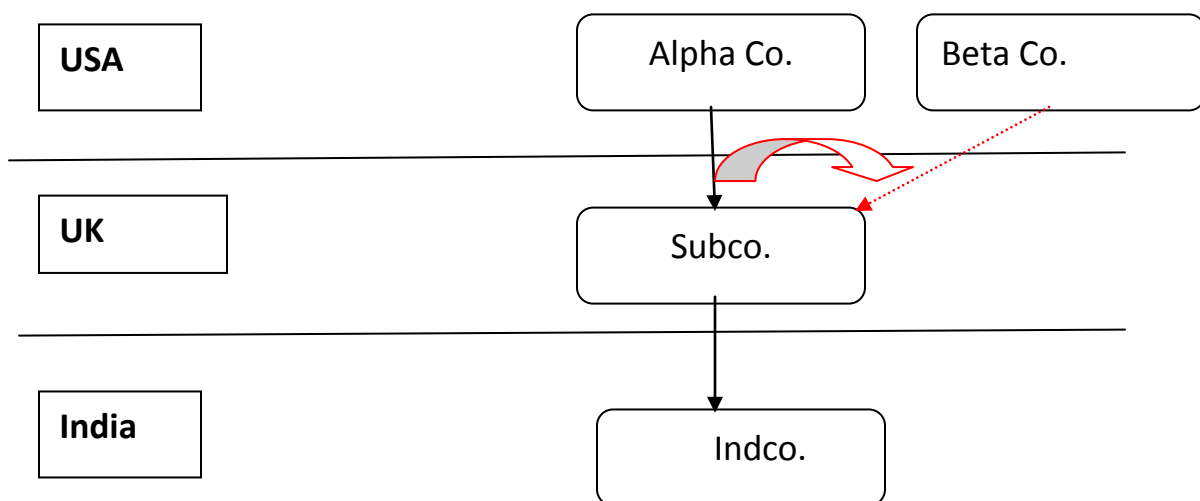

In this case, on transfer of shares of Subco to Beta Co., India will have the right of taxation under explanation 5 of section 9(1)(i) of domestic law as well as under the India-US treaty. UK will have a right of tax as company Subco is situated in UK (except where US-UK treaty provides exemption or UK does not tax a non-resident on capital gains). The US will have a right of tax of its resident company Alpha. All three countries will tax the same income. UK will not give credit for taxes paid in India under the India-UK treaty as the taxable person Alpha is neither a resident of India nor of the UK. The US will also not give credit for taxes paid in India as it does not consider it a foreign source income.

Illustration -II

Let us assume in the above illustration that Alpha is a resident of Germany (and not of the US). Article 13 of the Indo-Germany DTAA (based on OECD MC) reads as under -

ARTICLE 13 - Capital gains - 1. Gains derived by a resident of a Contracting State from the alienation of immovable property situated in the other Contracting State may be taxed in that other State.

2. Gains from the alienation of movable property forming part of the business property of a permanent establishment which an enterprise of a Contracting State has in the other Contracting State or of movable property pertaining to a fixed base available to a resident of a Contracting State in the other Contracting State for the purpose of performing independent personal services, including such gains from the alienation of such a permanent establishment (alone or with the whole enterprise) or of such fixed base, may be taxed in that other State.

3. Gains from the alienation of ships or aircraft operated in international traffic or movable property pertaining to the operation of such ships or aircraft shall be taxable only in the Contracting State in which the place of effective management of the enterprise is situated.

4. Gains from the alienation of shares in a company which is a resident of a Contracting State may be taxed in that State.

5. Gains from the alienation of any property other than that referred to in paragraphs 1 to 4 shall be taxable only in the Contracting State of which the alienator is a resident."

On transfer of shares of Subco by company Alpha to Beta, it is taxable in India under explanation 5 of section 9(1)(i) as transfer of shares of a foreign company.

The relevant issue here is whether the gains are taxable under the India-Germany treaty. First of all, for the purpose of taxation right under the treaty, there should be alienation of share of an Indian company. In the present case, it is share of the foreign company which is being alienated and not of the Indian company. However, if it is treated as a transfer of share of the Indian company under the definition of "transfer" under section 2(47) being indirect disposal of asset, then the term "alienation" should have the same meaning as the term "transfer" under the domestic law. Further, the gains should arise **from** alienation of share and not **through** transfer as is the case here.

Recommendations

In view of the above, in order to provide certainty to foreign investors, it may be clarified that where capital gains arising to a non-resident person on account of transfer of shares or interest in a foreign company or entity are taxable under section 9(1)(i) of the Act and there is a DTAA with country of residence of the non-resident, then such capital gains shall not be taxable in India unless

- (i) the DTAA provides a right of taxation of capital gains to India based on its domestic law; or**
- (ii) the DTAA specifically provides right of taxation to India on transfer of shares or interest of a foreign company or entity.**

4.16 Treating assessee in default for non-deduction of tax on payments to non-residents

Submission by the Stakeholders

Parliament is competent to make prospective as well retrospective laws but no retrospective law should penalize a person who had complied with the law as existing at the relevant time.

Article 20(1) of the Constitution provides certain safeguards as regards a retrospective amendment by providing that no person can be convicted for any offence except for a violation of a law in force at the time of action charged an offence, nor be subjected to a penalty greater than that which might have been inflicted under the law in force at the time of offence.

The retrospective amendment relating to indirect transfer may result in initiation of proceedings under section 201 of the Act for non-deduction of tax in the past (say in years 2011 or before) on transfer of shares of a foreign company having underlying assets in India and declaring such persons as assessee in default. Alternately, such person may also be treated as a representative assessee of the seller of shares of foreign company and tax may be demanded from such person. In both situations the person is being penalized for no fault of his own.

A person responsible for deduction of tax is the statutory agent of the Government for purposes of TDS. The principal could not tell his agent that, though the agent was right in not deducting tax at source on the basis of the law as it then stood, the agent should now pay up because of a change in law made by the principal. This would be contrary to Article 14 of the Constitution as being harsh, unreasonable and arbitrary. It would be "really unjust and contrary to all principals of equity" for a party who has not deducted tax at source – and who according to the Supreme Court was right in doing so – to now be called upon to pay the tax.²⁴

In the case of Rai Ramkrishna & Ors. Vs. State of Bihar²⁵ the Hon'ble Court quashed the imposition of retrospective tax because it found such imposition against the principal of equity and it was held that if the retrospective feature of a law is unreasonable, arbitrary and burdensome, the statute cannot be sustained.

Analysis

A person, who did not deduct tax based on the law as existed at the time of transaction, cannot be asked to go back in time and deduct tax based on the law amended retrospectively, as of now. A retrospective amendment cannot demand such action from any person subject to tax laws in a country. If a person, who has carried out a transaction in the past and has made full payments to the seller, is asked to make payment of tax (which is the liability of the seller) to the Revenue, then it would comprise a complete loss to such person. Such a loss does not arise out of any fault of his but because the earlier absence of such provision in the law. Hence, a person should not be penalized for non-deduction of tax in respect of a transaction that took place before the amendment of law.

Recommendations

In view of the above, the Committee recommends that no person should be treated as assessee in default under section 201 of the Act, or a representative assessee of a non-resident, in respect of a transaction of transfer of shares of a foreign company having underlying assets in India and where gains arising on such transfer is

²⁴ Opinion expressed by Shri S.E. Dastur, eminent Senior Advocate, in his public lecture on 20.3.2012.

²⁵ 1964 (1)SCC897

taxable in India on account of retrospective amendments carried out through Finance Act, 2012.

①

F. No.A.50050/95/2012-Ad.I
Government of India
Ministry of Finance
Department of Revenue

New Delhi Dated 17th July, 2012

OFFICE MEMORANDUM

Sub.:- Constitution of an Expert Committee on GAAR to undertake stakeholder consultations to finalize the guidelines for General Anti Avoidance Rule (GAAR)-Reg.

An Expert Committee on GAAR has been constituted with the approval of the Prime Minister to undertake stakeholder consultations and finalise the guidelines for General Anti Avoidance Rule (GAAR). This Committee would manage the consultation process and finalise the draft GAAR Guidelines. The Expert Committee consist of the following persons:-

- | | | | |
|-------|---|---|----------|
| (i) | Dr. Parthasarathi Shome | - | Chairman |
| (ii) | Shri N. Rangachary, former Chairman,
IRDA & CBDT | - | Member |
| (iii) | Dr. Ajay Shah, Professor, NIPFP | - | Member |
| (iv) | Shri Sunil Gupta, Joint Secretary, Tax
Policy & Legislation, Deptt. of Revenue | - | Member |

The terms of reference of the Committee is to.-

- (i) Receive comments from stakeholders and the general public on the draft GAAR guidelines which have been published by the Government on its website.
- (ii) Vet and rework the guidelines based on this feedback and publish the second draft of the GAAR guidelines for comments and consultations.
- (iii) Undertake widespread consultations on the second draft GAAR guidelines.
- (iv) Finalise the GAAR guidelines and a roadmap for implementation and submit these to the Government.

2

- 2 -

The Committee will work to the following time schedule:-

- (i) Receive comments from stakeholders and general public till end - July 2012.
- (ii) Vet and rework the guidelines based on this feedback and publish the second draft GAAR guidelines by 31 August, 2012.
- (iii) Finalise the GAAR guidelines and a roadmap for implementation and submit these to the Government by 30 September, 2012.

2. The Department of Revenue shall provide all necessary support to the Expert Committee to facilitate its work including office assistance and assistance to facilitate consultations.

3. The non-official members of the Committee shall be allowed travelling allowance and daily allowance as admissible to the Secretary to the Government of India.

M. L. Meena
(M.L. Meena)

Joint Secretary to the Government of India

Copy to:

- (i) Dr. Parthasarathi Shome.
- (ii) Shri N. Rangachary, former Chairman, IRDA & CBDT.
- (iii) Dr. Ajay Shah, Professor, NIPFP.
- (iv) Shri Sunil Gupta, Joint Secretary (TPL), Deptt. of Revenue.
- (v) Joint Secretary, ES-I, PMO.
- (vi) PPS to Finance Secretary.
- (vii) PPS to Chairman (CBDT).

M. L. Meena
(M.L. Meena) 17.7.12.

Joint Secretary to the Government of India

126782/16
Ambari 1

689/2012
35-12-11

PRIME MINISTER'S OFFICE

South Block,
New Delhi - 110 011.

Please refer to this office's ID of even number dated 13.7.2012 regarding constitution of an Expert Committee on GAAR.

2. Prime Minister has approved the following additional Terms of Reference for the aforesaid Committee :

(v) Examine the applicability of the amendment on taxation of non-resident transfer of assets where the underlying asset is in India, in the context of FIIs operating in India purely for portfolio investment.

3. The Expert Committee on GAAR may examine the issue and submit its recommendations to the government by 31st August, 2012.

4. The undersigned is directed to request DoR to issue the orders communicating the additional ToR, immediately.

(B.V.R. Subrahmanyam)
Joint Secretary to PM

Finance Secretary

PMO ID No. 280/31/C/19/2012 ES.1

Dated : 30.7.2012

Page 2

F.No.A.50050/95/2012-Ad.I
Government of India
Ministry of Finance
Department of Revenue

New Delhi, dated the 1st September, 2012

OFFICE MEMORANDUM

Sub: Constitution of an Expert Committee on GAAR to undertake stakeholder consultations to finalize the guidelines for General Anti Avoidance Rules (GAAR) – reg.

The undersigned is directed to refer to Department of Revenue's O.M. of even numbers dated 17th July, 2012 and 6th August, 2012 on the above cited subject and to say that the additional Terms of Reference (v) mandated for the Expert Committee on GAAR through O.M. dated 6th August, 2012 has been modified as under:

“(v) Examine the applicability of the amendment on taxation of non-resident transfer of assets where the underlying asset is in India, in the context of all non-resident taxpayers”.

2. The Expert Committee on GAAR may examine the above issue and submit its recommendations to the Government by 30th September, 2012.

M.L. Meena
M.L. Meena 01.9.12

Joint Secretary to the Government of India

Copy to:

- (i) Dr. Parthasarathi Shome, Chairman of the Committee
- (ii) Shri N. Rangachary, Member of the Committee
- (iii) Dr. Ajay Shah, Professor, NIPFP and Member of the Committee
- (iv) Shri Sunil Gupta, Joint Secretary (TPL-II), Department of Revenue and Member of the Committee
- (v) Shri B.V. Subrahmanyam, Joint Secretary, ES-I, PMO
- (vi) PS to FM
- (vii) PPS to Revenue Secretary
- (viii) PPS to Chairman (CBDT)

M.L. Meena
M.L. Meena 01.9.12

Joint Secretary to the Government of India

International practice on taxation of indirect transfers²⁶

An examination of the issues of taxation of indirect transfer in various jurisdictions reveals little uniformity of approach. Countries may be grouped in following categories following their taxation basis :

(i) Gains arising on transfer of shares of a company (incorporated anywhere) having substantial assets (all types) in a country are taxable in that jurisdiction;

(ii) Gains arising on transfer of shares of a company (incorporated anywhere) having substantial real estate assets (real estate company) in a country are taxable in that jurisdiction;

(iii) There is no statutory provision but indirect transfer of assets is taxable under anti-avoidance rules.

(iv) There is no tax on capital gains arising on transfer of shares of a company in that jurisdiction. It may be in respect of all types of companies or only for listed companies or all companies other than real estate companies.

Source v/s residence based taxation systems

Most of the countries in the world, particularly developed countries, follow residence based taxation so that a non-resident is not taxable on capital gains arising in the source country. However, in case of real estate or immovable property, some of the countries follow source based taxation. In order to protect their tax base from indirect transfer, countries have either used substance vs rule doctrine or statutory provision to deem indirect transfer to have a source in that country.

Taxable indirect transfer but restricted to real estate, natural resources etc

For instance, in Singapore and USA, indirect disposal of real estate situated in that country is taxable. Similar is the position in Russia and Australia except that the foreign entity (whose shares/interest are being transferred) should have more than 50% of its assets consisting of immovable property in that

²⁶ Based on submissions made by professional companies, information available in public domain.

country. In Canada, the foreign entity (whose shares/interest are being transferred) should have more than 50% of its assets consisting of immovable property, resource property or timber resources in that country.

Indirect transfer taxable under anti-avoidance rule

In China, indirect transfer of assets situated in China is taxable under its general anti avoidance rules. The Circular No 698 dated 10 Dec 2009 was issued by the Chinese authorities with retrospective effect from 1 Jan 2008. The circular requires that when a foreign investor transfers a Chinese resident enterprise indirectly, if the actual tax rate margin is lower than 12.5% in the country of transferor or that country does not levy income tax to its residents on overseas income, then the enterprise needs to provide detailed information to tax administration. The circular further provides that if a foreign investor (actual controlling party) transfers the equity in a Chinese resident enterprise indirectly via arrangements such as through the misuse of the corporate form without a reasonable business purpose to avoid corporate income tax liability, the relevant tax authority holds the right to recharacterise the equity transfer deal according to the economic substance and ignore the existence of the offshore holding company used for the tax arrangement. In Brazil²⁷, intermediate company used for transfer of assets in Brazil are disregarded if it is not for bonafide purpose or does not have any business purpose. Consequently, tax benefit is denied by adopting look through approach.

Indirect transfer taxable under statutory provisions

In Israel, foreign companies are subject to Israeli tax on their capital gains relating to:

- (i) An asset located abroad that is primarily a direct or indirect right to an asset, inventory or real estate in Israel or to a real estate association (an entity whose primary assets relate to Israel), or
- (ii) A right to a nonresident entity that primarily represents a direct or indirect right to property in Israel.

Tax is imposed on the portion of the consideration that relates to property in Israel. Exemption is provided to foreign residents if capital gains from:

²⁷ Brazil's Supplementary Law No 104.

- (i) Disposal of securities traded on the stock exchanges (within Israel or overseas)
- (ii) Disposal of shares in a research – intensive company.
- (iii) Gains derived with respect to venture capital funds that obtain an exemption ruling in advance. To obtain such ruling, a fund must inter alia devote >US\$ 10 million to Israel – related industrial or research – intensive companies.

Thus, Israel taxes all transfers relating to assets situated in Israel (without any threshold) but in a proportionate manner and with some exceptions.

MODEL CONVENTIONS

UN Model Convention

Article 13

CAPITAL GAINS

1. Gains derived by a resident of a Contracting State (residence country) from the alienation of **immovable property** referred to in Article 6 and situated in the other Contracting State (source country) may be taxed in that other State.

2. Gains from the alienation of movable property forming part of the **business property of a permanent establishment** which an enterprise of a Contracting State has in the other Contracting State or of movable property pertaining to a fixed base available to a resident of a Contracting State in the other Contracting State for the purpose of performing independent personal services, including such gains from the alienation of such a permanent establishment (alone or with the whole enterprise) or of such fixed base, may be taxed in that other State.

3. Gains from the **alienation of ships or aircraft** operated in international traffic, boats engaged in inland waterways transport or movable property pertaining to the operation of such ships, aircraft or boats, shall be taxable only in the Contracting State in which the place of effective management of the enterprise is situated.

4. Gains from the alienation of **shares of the capital stock of a company**, or of an interest in a partnership, trust or estate, the property of which **consists directly or indirectly principally of immovable property situated in a Contracting State** may be taxed in that State. In particular:

(a) Nothing contained in this paragraph shall apply to a company, partnership, trust or estate, other than a company, partnership, trust or estate engaged in the business of management of immovable properties, the property of which consists directly or indirectly principally of immovable property used by such company, partnership, trust or estate in its business activities.

(b) For the purposes of this paragraph, "**principally**" in relation to ownership of immovable property means the value of such immovable

property exceeding 50 per cent of the aggregate value of all assets owned by the company, partnership, trust or estate.

6. Gains from the alienation of any property other than that referred to in paragraphs 1, 2, 3, 4 and 5 shall be taxable only in the Contracting State of which the alienator is a resident State” (emphasis supplied)

Thus, para (1) provides a distributive rule in respect of immovable property. For instance, if a resident of country A transfers its immovable property situated in country B, then, Country B will have a right of taxation of gains and Country A will eliminate double taxation either by credit or exemption method.

Para (2) deals with capital assets connected with a permanent establishment, para (3) with ships and aircrafts. Para (4) is a distributive rule covering indirect transfer of immovable property. This can be illustrated as under –

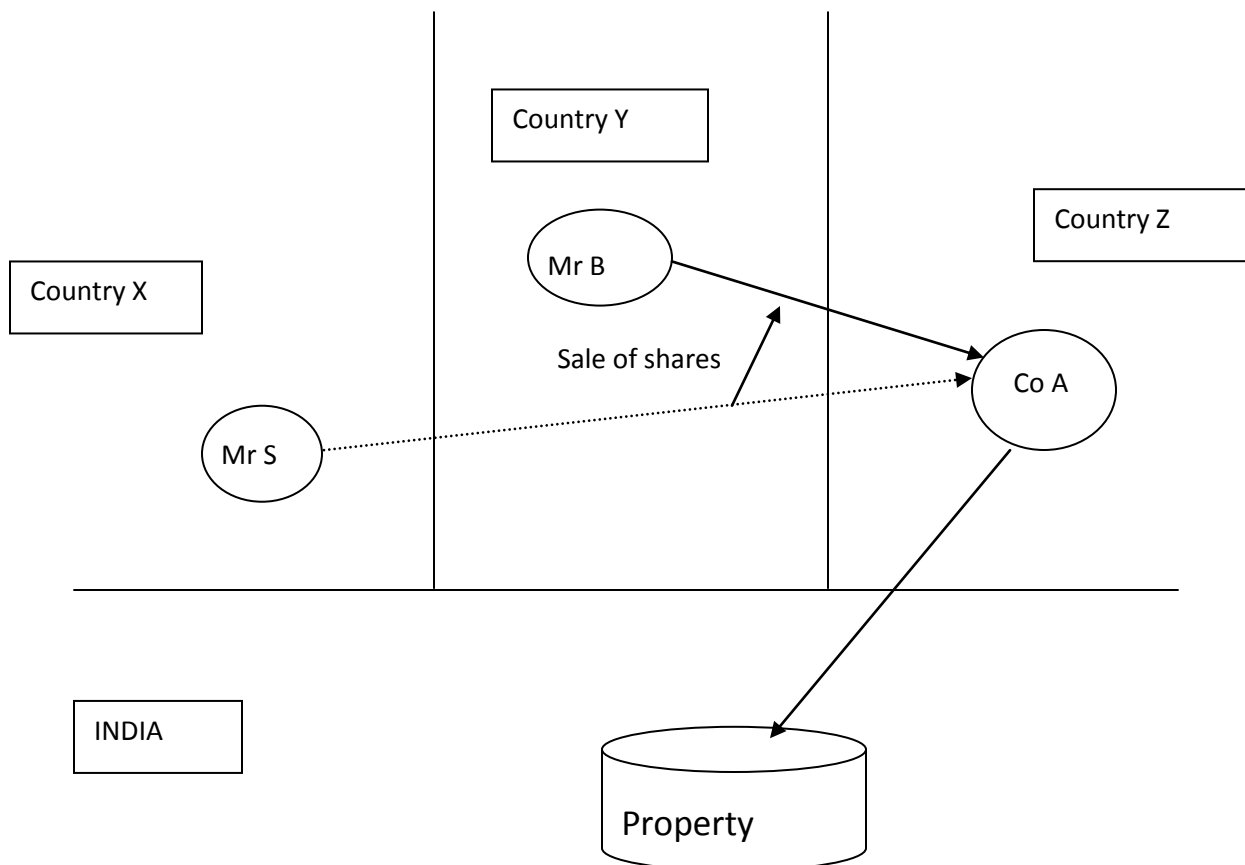

The extreme possibilities are considered here. Company A, resident of State Z, has invested in an immovable property situated in India. Co A has no other assets. Mr S is a sole share holder of the Co A and he is resident of State X. Mr S sells the share of Co A to Mr B, a resident of State Y. Both Mr S and Mr B are non-residents in India. Applicable treaty in this case is the DTAA between India and State X based on UN MC. Under article 13(4), India will have a right of taxation, even if there is no direct transfer of assets in India.

The anti-abuse nature of Article 13(4) is explained in United Nations, Manual for the Negotiation of Bilateral Tax Treaties between Developed and Developing Countries (New York, 2003- Observations on Art. 13)²⁸ as under

"Paragraph 4 of Article 13 ... is designed to prevent avoidance of taxes on the gains from the sale of immovable property through the use of real-estate holding companies and similar devices. Taxing the gain derived from the sale of an interest in such an entity is necessary, due to the ease with which taxpayers otherwise would avoid tax on the sale of immovable property."

In light of these considerations, it is clear that a provision such as Art. 13(4) is targeted at preventing a rule-shopping tax planning tool already addressed by several states in their treaty practice. The purpose of Article 13(4) is to put the alienation of shares in immovable property companies and the alienation of the underlying immovable property on an equal footing from a treaty regime perspective. However, it is important to note that the prevention aspect pertains to the real estate sector only.

OECD Model Convention

The Article 13(4) of the OECD MC reads as under –

"4. Gains derived by a resident of a Contracting State from the alienation of shares deriving more than **50 per cent** of their value **directly or indirectly** from **immovable property** situated in the other Contracting State may be taxed in that other State." (emphasis supplied)

It is similar to UN MC of 2003. The Commentary on this article has suggested following restrictions-

(i) to restrict the application of the provision to cases where the alienator holds a certain level of participation in the entity;

²⁸ Stefano Simontachji, "Immovable Property Companies as defined in article 13(4) of OECD MC", IBFD (Jan, 2006), Bulletin –Tax Treaty Monitor, p 29.

(ii) to consider that the paragraph should not apply to gains derived from the alienation of shares of companies that are listed on an approved stock exchange of one of the States;

(iii) to gains derived from the alienation of shares in the course of a corporate reorganization; or

(iv) where the immovable property from which the shares derive their value is immovable property (such as a mine or a hotel) in which a business is carried on.

However, these are left to States to decide through bilateral negotiations.

Direct Investment vs. Synthetic Investment (P-Notes)

Direct Investment

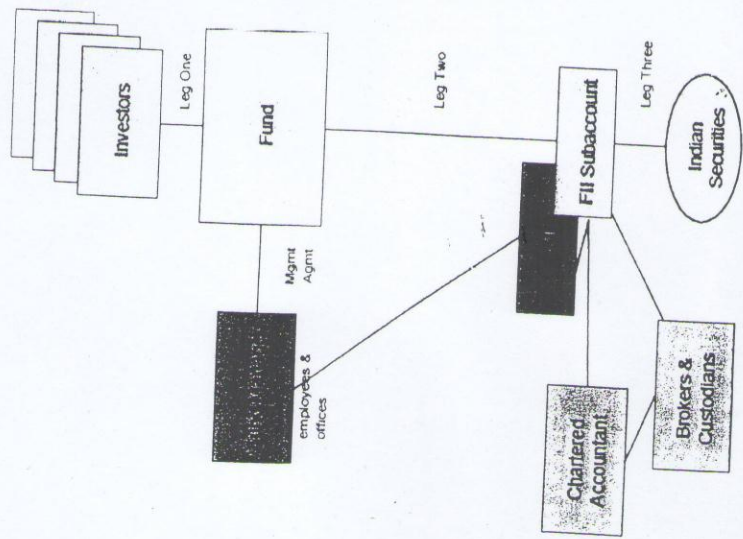

Synthetic Investment (P Notes)

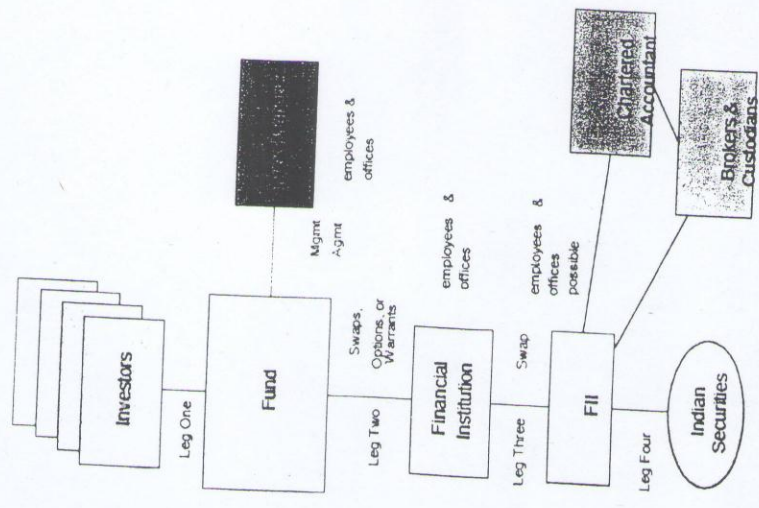

Ban on retroactive taxation

Constitutional provisions from other jurisdictions²⁹

1. Brazil³⁰:

The Article 150, subsection II, item "a", of the Federal Constitution prohibits charging or increase of taxes in relation to past taxable events.

"Article 150. *Without prejudice to any other guarantees ensured to the taxpayers, the Union, the states, the Federal District and the municipalities are forbidden to:*

- I. *Impose or increase a tribute*
- II. *Institute unequal treatment for taxpayers who are in an equivalent situation, it being forbidden to establish any distinction by reason of professional occupation or function performed by them, independently of the juridical designation of their incomes, titles or rights;*
- III. **Collect tributes:**
 - a. for taxable events that occurred before the law which instituted or increased such tributes came into force;**
 - b. in the same fiscal year in which the law which instituted or increased such tributes was published;**
- IV. *use a tribute for the purpose of confiscation;*
- V. *establish limitations on the circulation of persons or goods, by means of interstate or intermunicipal tributes, except for the collection of toll fees for the use of highways maintained by the Government;*
- VI. *institute taxes on:*
 - a. the property, income or services of one another;*
 - b. temples of any denomination;*
 - c. the property, income or services of political parties, including their foundations, of worker unions, of non-profit education and social assistance institutions, observing the requirements of the law;*
 - d. books, newspapers, periodicals and the paper intended for the printing thereof.*

²⁹ Source: information provided by various stakeholders to the Expert Committee.

³⁰ The letter dated 20 Sept.2012 of Mr Carlos Durate, The Ambassador, Embassy of Brazil, New Delhi.

2. Greece:

"Article 78

1. *No tax shall be levied without a statute enacted by Parliament, specifying the subject of taxation and the income, the type of property, the expenses and the transactions or categories thereof to which the tax pertains.*

2. A tax or any other financial charge may not be imposed by a retroactive statute effective prior to the fiscal year preceding the imposition of the tax.

3. *Exceptionally, in the case of imposition or increase of an import or export duty or a consumer tax, collection thereof shall be permitted as of the date on which the Bill shall be tabled in Parliament, on condition that the statute shall be published within the time-limit specified in article 42 paragraph 1, and in any case not later than ten days from the end of the Parliamentary session.*

4. *The object of taxation, the tax rate, the tax abatements and exemptions and the granting of pensions may not be subject to legislative delegation.*

This prohibition does not preclude the determination by law of the manner of assessing the share of the State or public agencies in general in the automatic increase on value or private real estate property adjoining the site of construction of public works and resulting exclusively therefrom.

5. *It shall, exceptionally, be permitted to impose by means of delegation granted in framework by statute, balancing or counteractive charges or duties, and to impose, within the framework of the country's international relations to economic organizations, economic measures or measures concerning the safeguarding of the country's foreign exchange position."*

3. Mexico

Article 14

Law shall not be applied retrospectively by any person.

No one shall be deprived of her life, freedom, estate, possession or rights but by a judicial ruling issued by a Court which is pre-existent to the respective trial and in which due process of law has been enforced.

Analogical reasoning and the majority of reason standard of review shall be both forbidden in resolving criminal trials. Punishments ruled with reference to criminal trials shall always be established by law.

In those trials under Civil jurisdiction, resolutions shall be made by either literal or legal interpretations of law. Whenever such interpretations are impossible to be made, the resolutions shall be made by interpreting the general principles of law.

4. Mozambique

Article 201

In the Republic of Mozambique, law may only be retroactive when this is to the benefit of citizens and other legal persons.

5. Paraguay

Article 14 About the Non-retroactivity of Laws

No law will be retroactive, except if it were to the defendant's or convict's advantage.

6. Peru

Article 74

Taxes are set up, modified or abolished, and exemptions are granted exclusively by law or legislative decree in case of delegation of powers, except for tariffs and rates, which are regulated by executive decree.

Regional and local governments may set up, modify and eliminate taxes and rates or exempt the same within their jurisdiction and within the limits defined by law. In exercising its taxing power, the State shall respect the principle of the legal reservation and those concerning equality and respect for basic rights of the person. **No tax shall have confiscatory nature.**

Budget acts and emergency decrees shall not contain provisions on taxes. **Laws concerning annual taxes come into force on the first day of January of the year following their enactment.**

Tax provisions set forth in violation of this article are null and void.

7. Romania

Article 15

(1) All citizens enjoy the rights and freedoms granted to them by the Constitution and other laws, and have the duties laid down thereby.

(2) **The law shall only act for the future, except for the more favourable criminal or administrative law.**

8. Russia

Article 57

Everyone shall be obliged to pay the legally established taxes and dues. **Laws introducing new taxes or deteriorating the position of taxpayers may not have retroactive effect.**

9. Slovenia

Article 155 (Prohibition of Retroactive Effect of Legal Acts)

(1) **Laws and other regulations and general legal acts cannot have retroactive effect.**

(2) Only a law may establish that certain of its provisions have retroactive effect, if this is required in the public interest and provided that no acquired rights are infringed thereby.

10. Sweden

Chapter 2 Article 10

(1) No penalty or other penal sanction may be imposed in respect of an act which was not subject to any penal sanction at the time it was committed. Neither may a more severe penal sanction be imposed than that which was prescribed when the act was committed. The provisions thus laid down with respect to penal sanctions apply likewise with respect to confiscation or any other special legal effects attaching to criminal offenses.

(2) **No State taxes, charges, or fees may be levied except insofar as they were laid down in provisions which were in force when the circumstances arose which occasioned the liability for the tax, charge, or fee.** Should the Parliament find that specific reasons so warrant, it may be provided under an Act of

law that State taxes, charges, or fees shall be levied even although no such act had entered into force when the aforementioned circumstances occurred, provided that the Government or a Committee of the Parliament had submitted a proposal to this effect to the Parliament at the time concerned. For the purposes of the foregoing provisions, any written communication from the Government to the Parliament announcing that a proposal of this nature will be forthcoming shall be equated with a formal proposal. The Parliament may furthermore prescribe that exceptions shall be made from the provisions of the first sentence if it considers that this is warranted by specific reasons connected with war, the danger of war, or severe economic crisis.

11. Venezuela

Article 24:

No legislative provision shall be retroactive effect, except where it imposes a lesser penalty. Procedural laws shall apply from the moment they go into effect, even to proceedings already in progress; however, in criminal proceedings, evidence already admitted shall be weighed in accordance with the laws that were in effect when the evidence was admitted, insofar as this benefits the defendant. When these are doubts as to the rule of law that is to be applied, the most beneficial to the defendant will prevail.

COMPARISON OF INDIRECT TRANSFER PROVISIONS 2009-2012

Sl.No.	Indirect Transfer Provisions in Finance Act, 2012.	Indirect Transfer Provisions in DTC 2010	Indirect Transfer Provisions in DTC 2009
	<p>9. (1) The following incomes shall be deemed to accrue or arise in India :—</p> <p>All income accruing or arising, whether directly or indirectly, through or from any business connection in India, or through or from any property in India, or through or from any asset or source of income in India, [* * *] or through the transfer of a capital asset situate in India.</p> <p>[Explanation 1].—For the purposes of this clause—</p> <p>(a) in the case of a business of which all the operations are not carried out in India, the income of the business deemed under this clause to accrue or arise in India shall be only such part of the income as is reasonably attributable to the operations carried out in India ;</p> <p><u>Explanation to clause(14) to section 2 :</u></p> <p>For the removal of doubts, it</p>	<p>5. (1) The income shall be deemed to accrue in India, if it accrues, whether directly or indirectly, through or from:</p> <p>(a) any business connection in India;</p> <p>(b) any property in India;</p> <p>(c) any asset or source of income in India; or</p> <p>(d) the transfer of a capital asset situated in India.</p> <p>For the purposes of clause (a) of sub-section (1), in the case of a business of which all the operations are not carried out in India, the income of the business deemed to accrue in India shall be only such part of the income as is reasonably attributable to the operations carried out in India.</p> <p><u>Item (g) to sub-clause (4) to clause (5) of DTC, 2010:-</u></p> <p>The income deemed to</p>	<p>5. (1) The income shall be deemed to accrue in India, if it accrues, whether directly or indirectly, through or from:</p> <p>(a) a business connection in India;</p> <p>(b) a property in India;</p> <p>(c) an asset or source of income in India; or</p> <p>(d) the transfer, directly or indirectly, of a capital asset situate in India.</p> <p>For the purposes of clause (a) of sub-section (1), in the case of a business of which all the operations are not carried out in India, the income of the business deemed to accrue in India shall be only such part of the income as is reasonably attributable to those operations carried out in India.</p>

<p>is hereby clarified that "property" includes and shall be deemed to have always included any rights in or in relation to an Indian company, including rights of management or control or any other rights whatsoever;</p> <p><u>Explanation 2 to clause(47) of section 2 :</u></p> <p>For the removal of doubts, it is hereby clarified that "transfer" includes and shall be deemed to have always included disposing of or parting with an asset or any interest therein, or creating any interest in any asset in any manner whatsoever, directly or indirectly, absolutely or conditionally, voluntarily or involuntarily, by way of an agreement (whether entered into in India or outside India) or otherwise, notwithstanding that such transfer of rights has been characterised as being effected or dependent upon or flowing from the transfer of a share or shares of a company registered or incorporated outside India;</p> <p><u>Explanation 4 to clause (i) of section 9 :</u></p> <p>For the removal of doubts, it is hereby clarified that the expression "through" shall mean and include and shall be deemed to have always meant and included "by means of", "in consequence of" or "by</p>	<p>accrue in India under subsection (1) shall, in the case of anon-resident, not include the following, namely:—</p> <p>income from transfer, outside India, of any share or interest in a foreign company unless at any time in twelve months preceeding the transfer, the fair marketvalue of the assets in India, owned, directly or indirectly, by the company, represent at least fifty per cent. of the fair market value of all assets owned by the company;</p> <p><u>Sub-clause (6) to clause 5 of DTC, 2010:-</u></p> <p>Where the income of a non-resident, in respect of transfer, outside India, of anyshare or interest in a foreign company, is deemed to accure in India under clause (d) of subsection (1), it shall be computed in accordance with the following formula—</p> $A \times B/C$ <p>Where A = Income from the transfer computed in accordance with provisions of this Code as if the transfer was effected in India;</p> <p>B = fair market value of the assets in India, owned, directly or indirectly, by the company;</p>	
---	---	--

<p>reason of".</p> <p><u>Explanation 5 to clause (i) of Section 9 :</u></p> <p>For the removal of doubts, it is hereby clarified that an asset or a capital asset being any share or interest in a company or entity registered or incorporated outside India shall be deemed to be and shall always be deemed to have been situated in India, if the share or interest derives, directly or indirectly, its value substantially from the assets located in India</p>	<p>C = fair market value of all assets owned by the company.</p>	
--	--	--